

Dell PowerEdge
R210 II Systems
Owner's Manual

Regulatory Model E10S Series
Regulatory Type E10S002



Notes, Cautions, and Warnings



NOTE: A NOTE indicates important information that helps you make better use of your computer.



CAUTION: A CAUTION indicates potential damage to hardware or loss of data if instructions are not followed.



WARNING: A WARNING indicates a potential for property damage, personal injury, or death.

© 2013 Dell Inc.

Trademarks used in this text: Dell™, the DELL logo, and PowerEdge™ are trademarks of Dell Inc.

2013 - 09

Rev. A01

Contents

1	About Your System	11
	Accessing System Features During Startup	11
	Front-Panel Features and Indicators	12
	Back-Panel Features and Indicators	14
	Guidelines for Connecting External Devices	15
	NIC Indicator Codes	16
	Diagnostic Lights	17
	System Messages	19
	Warning Messages	22
	Diagnostics Messages	22
	Alert Messages	22
	Other Information You May Need	23
2	Using the System Setup Program and Boot Manager	25
	Choosing the System Boot Mode	25
	Entering the System Setup Program	26
	Responding to Error Messages	26
	System Setup Options	27

Main Screen	27
Memory Settings Screen	29
Processor Settings Screen	29
SATA Settings Screen.	30
Boot Settings Screen	31
Integrated Devices Screen	31
PCI IRQ Assignments Screen.	32
Serial Communication Screen	33
Power Management Screen	34
System Security Screen	35
Exit Screen	37
Entering the Boot Manager	37
Using the Boot Manager Navigation Keys	38
Boot Manager Screen	38
Boot Settings Screen	39
System Utilities Screen	39
System and Setup Password Features.	40
Using the System Password	40
Using the Setup Password	42
Embedded System Management.	43
Baseboard Management Controller Configuration	44
Entering the BMC Setup Module	44
iDRAC6 Configuration Utility.	45
Entering the iDRAC6 Configuration Utility	45
3 Installing System Components	47
Recommended Tools	47
Inside the System.	48

Front Bezel (Optional)	49
Removing the Front Bezel	49
Installing the Front Bezel	49
Opening and Closing the System	50
Opening the System	50
Closing the System	51
Optical Drive (Optional)	52
Removing an Optical Drive	52
Installing an Optical Drive	54
Filler Panel	54
Removing a Filler Panel.	55
Installing a Filler Panel	55
Hard Drives	56
Removing a 3.5-Inch Hard Drive	56
Installing a 3.5-Inch Hard Drive.	58
Removing a 3.5-Inch Hard Drive From a Hard-Drive Carrier	59
Installing a 3.5-Inch Hard Drive Into a Hard-Drive Carrier	60
Expansion Card	61
Expansion Card Installation Guidelines	61
Removing an Expansion Card	61
Installing an Expansion Card	62
Expansion-Card Riser	63
Removing an Expansion-Card Riser	63
Installing an Expansion-Card Riser.	65
Internal USB Memory Key	65
Cooling Shroud	66
Removing the Cooling Shroud	67

Installing the Cooling Shroud	69
System Memory	69
General Memory Module	
Installation Guidelines	69
Mode-Specific Guidelines	70
Installing Memory Modules.	71
Removing Memory Modules	73
Cooling Fans	74
Removing a Cooling Fan	74
Installing a Cooling Fan	75
iDRAC6 Express Card (Optional)	76
Installing an iDRAC6 Express Card	76
Removing an iDRAC6 Express Card.	78
iDRAC6 Enterprise Card (Optional)	79
Installing an iDRAC6 Enterprise Card.	79
Removing an iDRAC6 Enterprise Card	81
VFlash Media (Optional)	82
Installing a VFlash Media Card	82
Removing a VFlash Media Card	82
Processor.	82
Removing a Processor	82
Installing a Processor.	86
Power Supply	87
Removing the Power Supply	87
Installing the Power Supply.	89
System Battery	89
Replacing the System Battery	89
Control Panel Assembly	91

Removing the Control Panel Assembly	91
Installing the Control Panel Assembly	93
System Board	93
Removing the System Board	93
Installing the System Board	95
4 Troubleshooting Your System	97
Safety First—For You and Your System	97
Troubleshooting System Startup Failure	97
Troubleshooting External Connections	97
Troubleshooting the Video Subsystem	98
Troubleshooting a USB Device	98
Troubleshooting a Serial I/O Device	99
Troubleshooting a NIC	99
Troubleshooting a Wet System	100
Troubleshooting a Damaged System	101
Troubleshooting the System Battery	102
Troubleshooting Power Supply	103
Troubleshooting System Cooling Problems	103
Troubleshooting a Fan	103
Troubleshooting System Memory	104
Troubleshooting an Internal USB Key	106
Troubleshooting an Optical Drive	107

	Troubleshooting a Hard Drive	108
	Troubleshooting an Expansion Card.	109
	Troubleshooting the Processor	110
5	Running the System Diagnostics	111
	Using Online Diagnostics	111
	Embedded System Diagnostics Features	111
	When to Use the Embedded System Diagnostics	112
	Running the Embedded System Diagnostics	112
	System Diagnostics Testing Options.	112
	Using the Custom Test Options	113
	Selecting Devices for Testing.	113
	Selecting Diagnostics Options	113
	Viewing Information and Results	113
6	Jumpers and Connectors.	115
	System Board Jumpers.	115
	System Board Connectors	116
	Disabling a Forgotten Password.	118
7	Getting Help.	119
	Contacting Dell.	119

Index 121

About Your System

Accessing System Features During Startup

The following keystrokes provide access to system features during startup.



Keystroke	Description
< F2 >	Enters the System Setup program. See "Using the System Setup Program and Boot Manager" on page 25.
< F10 >	Enters System Services, which opens the Dell Unified Server Configurator (USC). The Dell USC allows you to access utilities such as embedded system diagnostics. For more information, see the Unified Server Configurator documentation at support.dell.com/manuals .
< F11 >	Enters the Boot Manager, depending on the system's boot configuration. See "Using the System Setup Program and Boot Manager" on page 25.
< F12 >	Starts PXE boot.
< Ctrl > < E >	Enters the Baseboard Management Controller (BMC) or Integrated Dell Remote Access Controller (iDRAC) Configuration Utility, which allows access to the System Event Log (SEL) and configuration of remote access to the system. For more information, see the BMC or iDRAC user documentation at support.dell.com/manuals .
< Ctrl > < C >	Enters the SAS Configuration Utility. For more information, see your SAS adapter documentation.
< Ctrl > < R >	Enters the RAID configuration utility. For more information, see the documentation for your SAS RAID card.
< Ctrl > < S >	Enters the utility to configure NIC settings for PXE boot. For more information, see the documentation for your integrated NIC.

Front-Panel Features and Indicators

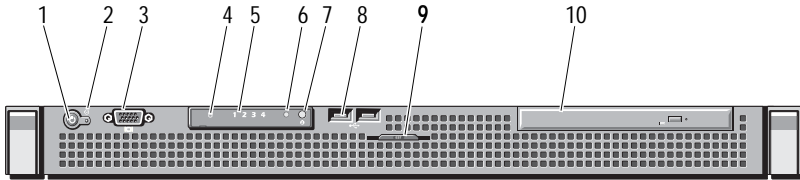
Figure 3-1. Front-Panel Features and Indicators



Item	Indicator, Button, or Connector	Icon	Description
1	Power-on indicator/ power button		<p>The power-on indicator lights when the system power is on.</p> <p>The power button controls the DC power supply output to the system. When the system bezel is installed, the power button is not accessible.</p> <p>NOTE: When powering on the system, the video monitor can take from several seconds to over 2 minutes to display an image, depending on the amount of memory installed in the system.</p> <p>NOTE: On ACPI-compliant operating systems, turning off the system using the power button causes the system to perform a graceful shutdown before power to the system is turned off.</p>
2	NMI button		<p>Used to troubleshoot software and device driver errors when using certain operating systems. This button can be pressed using the end of a paper clip.</p> <p>Use this button only if directed to do so by qualified support personnel or by the operating system's documentation.</p>





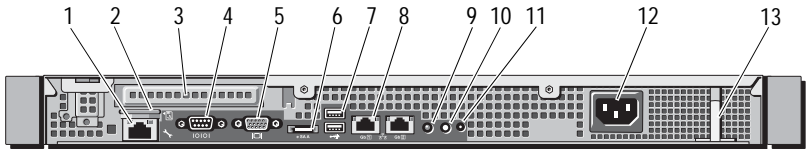

Item	Indicator, Button, or Connector	Icon	Description
3	Video connector		Connects a monitor to the system.
4	Hard-drive activity indicator		Lights up when the hard drive is in use.
5	Diagnostic indicator lights (4)		The four diagnostic indicator lights display error codes during system startup. See "Diagnostic Lights" on page 17.
6	System status indicator		Lights blue during normal system operation. Lights amber when the system needs attention due to a problem.
7	System identification button		The system identification buttons on the front and back panels can be used to locate a particular system within a rack. When one of the buttons is pushed, the system status indicators on the front and back panels light blue until one of the buttons is pushed again.
8	USB connectors (2)		Connect USB devices to the system. The ports are USB 2.0-compliant.
9	System identification panel		A slide-out panel for system information including the Express Service Tag, embedded NIC MAC address, and iDRAC6 Enterprise card MAC address. Space is provided for an additional label.
10	Optical drive (optional)		One optional slim-line SATA DVD-ROM or DVD+/-RW drive, or combination CD-RW/DVD drive (when available). NOTE: DVD devices are data only.

Back-Panel Features and Indicators

Figure 3-2 shows the controls, indicators, and connectors located on the system's back panel.

Figure 3-2. Back-Panel Features and Indicators



Item	Indicator, Button, or Connector	Icon	Description
1	iDRAC6 Enterprise port (optional)		Dedicated management port for the optional iDRAC6 Enterprise card.
2	VFlash media slot (optional)		Connects an external SD memory card for the optional iDRAC6 Enterprise card.
3	PCIe expansion card slot		Connects a PCI Express expansion card.
4	Serial connector		Connects a serial device to the system.
5	Video connector		Connects a VGA display to the system.
6	eSATA	eSATA	Connects additional storage devices.
7	USB connectors (2)		Connect USB devices to the system. The ports are USB 2.0-compliant.
8	Ethernet connectors (2)		Embedded 10/100/1000 NIC connectors.

Item	Indicator, Button, or Connector	Icon	Description
9	System status indicator		Lights blue during normal system operation. Lights amber when the system needs attention due to a problem.
10	System identification button		The system identification buttons on the front and back panels can be used to locate a particular system within a rack. When one of the buttons is pushed, the system status indicators on the front and back panels light blue until one of the buttons is pushed again.
11	System identification connector		Connects the optional system status indicator assembly through the optional cable management arm.
12	Power supply		250 W power supply.
13	Retention clip		Secures the power cable.

Guidelines for Connecting External Devices

- Turn off power to the system and external devices before attaching a new external device. Turn on any external devices before turning on the system (unless the documentation for the device specifies otherwise).
- Ensure that the appropriate driver for the attached device has been installed on the system.
- If necessary to enable ports on your system, use the System Setup program. See "Entering the System Setup Program" on page 26.

NIC Indicator Codes

Figure 3-3. NIC Indicator Codes

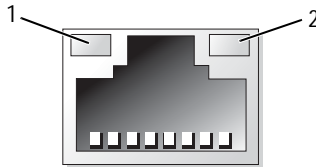

1 link indicator

2 activity indicator









Indicator	Indicator Code
Link and activity indicators are off	The NIC is not connected to the network.
Link indicator is green	The NIC is connected to a valid network link at 1000 Mbps.
Link indicator is amber	The NIC is connected to a valid network link at 10/100 Mbps.
Activity indicator is green blinking	Network data is being sent or received.

Diagnostic Lights

The four diagnostic indicator lights on the system front panel display error codes during system startup. Table 3-1 lists the causes and possible corrective actions associated with these codes. A highlighted circle indicates the light is on; a non-highlighted circle indicates the light is off.

Table 3-1. Diagnostic Indicator Codes

Code	Causes	Corrective Action
① ② ③ ④	The system is in a normal off condition or a possible pre-BIOS failure has occurred. The diagnostic lights are not lit after the system successfully boots to the operating system.	Plug the system into a working electrical outlet and press the power button.
① ② ③ ④	The system is in a normal operating condition after POST.	Information only.
① ② ③ ④	BIOS checksum failure detected; system is in recovery mode.	See "Getting Help" on page 119.
① ② ③ ④	Possible processor failure.	See "Troubleshooting the Processor" on page 110.
① ② ③ ④	Memory failure.	See "Troubleshooting System Memory" on page 104.
① ② ③ ④	Possible expansion card failure.	See "Troubleshooting an Expansion Card" on page 109.
① ② ③ ④	Possible video failure.	See "Getting Help" on page 119.

Code	Causes	Corrective Action
	Hard drive failure.	Ensure that the diskette drive and hard drive are properly connected. See "Hard Drives" on page 56 for information on the drives installed in your system.
	Possible USB failure.	See "Troubleshooting a USB Device" on page 98.
	No memory modules detected.	See "Troubleshooting System Memory" on page 104.
	System board failure.	See "Getting Help" on page 119.
	Memory configuration error.	See "Troubleshooting System Memory" on page 104.
	Possible system board resource and/or system board hardware failure.	See "Getting Help" on page 119.
	Possible system resource configuration error.	See "Getting Help" on page 119.
	Other failure.	Ensure that the optical drive and hard drives are properly connected. See "Troubleshooting Your System" on page 97 for the appropriate drive installed in your system. If the problem persists, see "Getting Help" on page 119.

System Messages

System messages appear on the screen to notify you of a possible problem with the system.



NOTE: If you receive a system message not listed in the table, check the documentation for the application that is running when the message appears or the operating system's documentation for an explanation of the message and recommended action.

Message	Causes	Corrective Actions
BIOS MANUFACTURING MODE detected. MANUFACTURING MODE will be cleared before the next boot. System reboot required for normal operation.	System is in manufacturing mode.	Reboot to take the system out of manufacturing mode.
Caution! NVRAM_CLR jumper is installed on system board. Please run SETUP.	NVRAM_CLR jumper is installed in the clear setting. CMOS has been cleared.	Move the NVRAM_CLR jumper to the default position (pins 3 and 5). See Figure 8-1 for jumper location. Restart the system and re-enter the BIOS settings. See "Using the System Setup Program and Boot Manager" on page 25.
Invalid configuration information - please run SETUP program.	An invalid system configuration caused a system halt.	Run the System Setup program and review the current settings. See "Using the System Setup Program and Boot Manager" on page 25.
Keyboard controller failure.	Faulty keyboard controller; faulty system board.	See "Getting Help" on page 119.

Message	Causes	Corrective Actions
Keyboard data line failure. Keyboard stuck key failure.	Keyboard cable connector is improperly connected or the keyboard is defective.	Reseat the keyboard cable. If the problem persists, see "Troubleshooting a USB Device" on page 98.
Manufacturing mode detected.	System is in manufacturing mode.	Reboot to take the system out of manufacturing mode.
Memory Initialization Warning: Memory size may be reduced.	Invalid memory configuration. The system will run but with less memory than is physically available.	Ensure that the memory modules are installed in a valid configuration. See "General Memory Module Installation Guidelines" on page 69.
No boot device available.	Faulty or missing optical drive subsystem, hard drive, or hard-drive subsystem, or no bootable USB key installed.	Use a bootable USB key, CD, or hard drive. If the problem persists, see "Troubleshooting a USB Device" on page 98, "Troubleshooting an Optical Drive" on page 107, and "Troubleshooting a Hard Drive" on page 108. See "Using the System Setup Program and Boot Manager" on page 25 for information on setting the order of boot devices.
PCI BIOS failed to install.	PCIe device BIOS (Option ROM) checksum failure detected during shadowing. Cables to expansion card loose; faulty or improperly installed expansion card.	Reseat the expansion card. Ensure that all appropriate cables are securely connected to the expansion card. If the problem persists, see "Troubleshooting an Expansion Card" on page 109.

Message	Causes	Corrective Actions
PCIe Training Error: Expected Link Width is x, Actual Link Width is y.	Faulty or improperly installed PCIe card in the specified slot.	Reseat the PCIe card in the specified slot number. See "Troubleshooting an Expansion Card" on page 109. If the problem persists, see "Getting Help" on page 119.
SATA Portx device not found.	There is no device connected to the specified SATA port.	Information only.
SATA port x device auto-sensing error. SATA port x device configuration error. SATA port x device error.	The drive connected to the specified SATA port is faulty.	Replace the faulty drive.
The amount of system memory has changed.	Memory has been added or removed or a memory module may be faulty.	If memory has been added or removed, this message is informative and can be ignored. If memory has not been added or removed, check the SEL to determine if single-bit or multi-bit errors were detected and replace the faulty memory module. See "Troubleshooting System Memory" on page 104.
Time-of-day not set - please run SETUP program.	Incorrect Time or Date settings; faulty system battery.	Check the Time and Date settings. See "Using the System Setup Program and Boot Manager" on page 25. If the problem persists, replace the system battery. See "System Battery" on page 89.

Message	Causes	Corrective Actions
Timer chip counter 2 failed.	Faulty system board.	See "Getting Help" on page 119.
TPM failure.	A TPM function has failed.	See "Getting Help" on page 119.
Warning! No micro code update loaded for processor n.	Micro code update failed.	Update the BIOS firmware. See "Getting Help" on page 119.

NOTE: For the full name of an abbreviation or acronym used in this table, see the *Glossary* on support.dell.com/manuals.

Warning Messages

A warning message alerts you to a possible problem and prompts you to respond before the system continues a task. For example, before you format a hard drive, a message will warn you that you may lose all data on the hard drive. Warning messages usually interrupt the task and require you to respond by typing *y* (yes) or *n* (no).



NOTE: Warning messages are generated by either the application or the operating system. For more information, see the documentation that accompanied the operating system or application.

Diagnostics Messages

The system diagnostic utilities may issue messages if you run diagnostic tests on your system. See "Running the System Diagnostics" on page 111 for more information about system diagnostics.

Alert Messages

Systems management software generates alert messages for your system. Alert messages include information, status, warning, and failure messages for drive, temperature, fan, and power conditions. For more information, see the systems management software documentation.

Other Information You May Need



WARNING: See the safety and regulatory information that shipped with your system. Warranty information may be included within this document or as a separate document.

- The rack documentation included with your rack solution describes how to install your system into a rack.
- The *Getting Started Guide* provides an overview of system features, setting up your system, and technical specifications.
- Any media that ships with your system that provides documentation and tools for configuring and managing your system, including those pertaining to the operating system, system management software, system updates, and system components that you purchased with your system.



NOTE: Always check for updates on support.dell.com/manuals and read the updates first because they often supersede information in other documents.

Using the System Setup Program and Boot Manager

The System Setup program is the BIOS program that enables you to manage your system hardware and specify BIOS-level options. From the System Setup program, you can:

- Change the NVRAM settings after you add or remove hardware
- View the system hardware configuration
- Enable or disable integrated devices
- Set performance and power management thresholds
- Manage system security

Choosing the System Boot Mode

The System Setup program also enables you to specify the boot mode for installing your operating system:

- BIOS boot mode (the default) is the standard BIOS-level boot interface.
- UEFI boot mode is an enhanced 64-bit boot interface based on Unified Extensible Firmware Interface (UEFI) specifications that overlays the system BIOS. See "Entering the Boot Manager" on page 37 for more information on this interface.

You must select the boot mode in the **Boot Mode** field of the **Boot Settings** screen of the System Setup program. Once you specify the boot mode, the system boots in the specified boot mode and you proceed then to install your operating system from that mode. Thereafter, you must boot the system to the same boot mode (BIOS or UEFI) to access the installed operating system. Trying to boot the operating system from the other boot mode will cause the system to halt immediately at startup.



NOTE: Operating systems must be UEFI-compatible (for example, Microsoft Windows Server 2008 x64 version) to be installed from the UEFI boot mode. DOS and 32-bit operating systems do not support UEFI and can only be installed from the BIOS boot mode.

Entering the System Setup Program

- 1 Turn on or restart your system.
- 2 Press < F2> immediately after you see the following message:

<F2> = System Setup

If your operating system begins to load before you press < F2>, allow the system to finish booting, and then restart your system and try again.

Responding to Error Messages

If an error message appears while the system is booting, make a note of the message. See "System Messages" on page 19 for an explanation of the message and suggestions for correcting errors.



NOTE: After installing a memory upgrade, it is normal for your system to display a message the first time you start your system.

Using the System Setup Program Navigation Keys

Keys	Action
Up arrow	Moves to the previous field.
Down arrow or < Tab>	Moves to the next field.
< Enter>, Spacebar, < + >, or < - >	Cycles through the settings in a field. In many fields, you can also type the appropriate value.
< Esc>	Exits the System Setup program and restarts the system if any changes were made.
< F1>	Displays the System Setup program's help file.



NOTE: For most of the options, any changes that you make are recorded but do not take effect until you restart the system.

System Setup Options

Main Screen

Dell Inc. (www.dell.com) Setup(c) Insyde Software, All Rights Reserved PowerEdge R210-II BIOS Version xx.yy.zz			
Service Tag: xnnnnnn		Asset Tag: xnnnnnnnnn	
System Time00:00:00 System DateMM/DD/YYYY			
Memory Settings<Enter> Processor Settings<Enter>			
SATA Settings<Enter>			
Boot Settings<Enter>			
Integrated Devices<Enter> PCI IRQ Assignment<Enter>			
Serial Communication<Enter>			
Power Management.....<Enter> System Security<Enter>			
Up,Down Arrow to select	SPACE, +, - to change	ESC to exit	F1 = Help



NOTE: The options for the System Setup program change based on the system configuration.



NOTE: The System Setup program defaults are listed under their respective options in the following sections, where applicable.

Option	Description
System Time	Sets the time on the system's internal clock.
System Date	Sets the date on the system's internal calendar.
Memory Settings	Displays information related to installed memory. See "Memory Settings Screen" on page 29.

Option	Description
Processor Settings	Displays information related to the processor (speed, cache size, and so on). See "Processor Settings Screen" on page 29.
SATA Settings	Displays a screen to enable or disable the integrated SATA controller and ports. See "SATA Settings Screen" on page 30.
Boot Settings	Displays a screen to specify the boot mode (BIOS or UEFI). For BIOS boot mode, you can also specify the boot devices. See "Boot Settings Screen" on page 31.
Integrated Devices	Displays a screen to enable or disable integrated device controllers and ports, and to specify related features and options. See "Integrated Devices Screen" on page 31.
PCI IRQ Assignment	Displays a screen to change the IRQ assigned to each of the integrated devices on the PCI bus, and any installed expansion card that requires an IRQ. See "PCI IRQ Assignments Screen" on page 32.
Serial Communication	Displays a screen to enable or disable the serial ports and specify related features and options. See "Serial Communication Screen" on page 33.
Power Management	Enables you to manage power usage of the processor, fans, and memory modules with preconfigured or customized settings. See "Power Management Screen" on page 34.
System Security	Displays a screen to configure the system password and setup password features. For more information, see "System Security Screen" on page 35, "Using the System Password" on page 40, and "Using the Setup Password" on page 42.
Keyboard NumLock (On default)	Determines whether your system starts up with the NumLock mode activated on 101- or 102-key keyboards (does not apply to 84-key keyboards).

Option	Description
Report Keyboard Errors (Report default)	Enables or disables reporting of keyboard errors during the POST. Select Report for host systems that have keyboards attached. Select Do Not Report to suppress all error messages relating to the keyboard or keyboard controller during POST. This setting does not affect the operation of the keyboard itself if a keyboard is attached to the system.
F1/F2 Prompt on Error (Enabled default)	<p>Enables the system to halt on errors during POST, which allows the user to observe events that may scroll by unnoticed during normal POST. The user can press < F1 > to continue or < F2 > to enter the System Setup program.</p> <p> CAUTION: When setting this option to Disabled, the system does not halt if an error occurs during POST. Any critical errors are displayed and logged in the system event log.</p>

Memory Settings Screen

Option	Description
System Memory Size	Displays the amount of system memory.
System Memory Type	Displays the type of system memory.
System Memory Speed	Displays the system memory speed.
Video Memory	Displays the amount of video memory.
System Memory Testing (Enabled default)	Specifies whether system memory tests are run at system boot. Options are Enabled and Disabled .

Processor Settings Screen

Option	Description
64-bit	Specifies if the processor supports 64-bit extensions.
Core Speed	Displays the processor clock speed.
Bus Speed	Displays the processor bus speed.

Option	Description
Processor Family-Model-Stepping	Displays the processor family and model.
Level 2 Cache	Displays the level 2 cache size.
Level 3 Cache	Displays the level 3 cache size.
Number of Cores	Displays the number of cores of the processor.
Logical Processor (Enabled default)	On processors that support Simultaneous Multi-Threading (SMT) technology, each processor core supports up to two logical processors. If this field is set to Enabled , the BIOS reports both logical processors. If set to Disabled , only one logical processor is monitored by the BIOS.
Virtualization Technology (Disabled default)	Enabled permits virtualization software to use the virtualization technology incorporated in the processor. NOTE: Disable this feature if your system will not be running virtualization software.
Execute Disable (Enabled default)	Enables or disables Execute Disable Memory Protection Technology.
Number of Cores per Processor (All default)	If set to All , the maximum number of cores in each processor is enabled.
Turbo Mode (Enabled default)	If Turbo Boost technology is supported by the processor, Turbo Mode is enabled or disabled.
C States (Enabled default)	When set to Enabled , the processor can operate in all available power states.

SATA Settings Screen

Option	Description
Embedded SATA (AHCI default)	Allows the embedded SATA to be set to Off , ATA , AHCI , or RAID modes.
Port A (Auto default)	Auto enables BIOS support for the device attached to SATA port A. Off disables BIOS support for the device.
Port B (Off default)	Auto enables BIOS support for the device attached to SATA port B. Off disables BIOS support for the device.

Option	Description
Port C (Off default)	Auto enables BIOS support for the device attached to SATA port C. Off disables BIOS support for the device.
Port D (Off default)	Auto enables BIOS support for the device attached to SATA port D. Off disables BIOS support for the device.
Port E (Auto default)	Auto enables BIOS support for the device attached to SATA port E. Off disables BIOS support for the device.
eSATA port (Auto default)	Auto enables BIOS support for the device attached to the eSATA port. Off disables BIOS support for the device.

Boot Settings Screen

Option	Description
Boot Mode (BIOS default)	 CAUTION: Switching the boot mode could prevent the system from booting if the operating system was not installed in the same boot mode. If the operating system supports Unified Extensible Firmware Interface (UEFI), you can set this option to UEFI . Setting this field to BIOS allows compatibility with non-UEFI operating systems. NOTE: Setting this field to UEFI disables the Boot Sequence , Hard-Disk Drive Sequence , and USB Flash Drive Emulation Type fields.
Boot Sequence Retry (Disabled default)	If this field is enabled and the system has failed to boot, the system re-attempts to boot after 30 seconds.

Integrated Devices Screen

Option	Description
User Accessible USB Ports (All Ports On default)	Enables or disables the user-accessible USB ports. Options are All Ports On , Only Back Ports On , and All Ports Off .
Internal USB Port (On default)	Enables or disables the internal USB port.

Option	Description
Embedded NIC1 and NIC2 (Enabled default)	Enables or disables the operating system interface of the NIC1 and NIC2 controllers. (The NICs may also be accessed through the system's management controller).
Embedded Gb NIC1 (Enabled with PXE default)	PXE support allows the system to boot from the network. Enabled with iSCSI Boot option is available if the NIC on board supports iSCSI.
MAC Address	Displays the MAC address for the NIC.
Embedded Gb NIC2 (Enabled default)	PXE support allows the system to boot from the network. Enabled with iSCSI Boot option is available if the NIC on board supports iSCSI.
MAC Address	Displays the MAC address for the NIC.
OS Watchdog Timer (Disabled default)	Sets a timer to monitor the operating system for activity, and aids in recovery if the system stops responding. When Enabled , the operating system is allowed to initialize the timer. When Disabled , the timer is not initialized. NOTE: This feature is usable only with operating systems that support WDAT implementations of the Advanced Configuration and Power Interface (ACPI) 3.0b specification.
Embedded Video Controller (Standard default)	Enables or disables BIOS support for the integrated video controller. NOTE: This field can be disabled only if an add-in video card is present. If this field is disabled, remote access features such as virtual KVM are not available.

PCI IRQ Assignments Screen

Option	Description
< <i>PCIe device</i> >	Use the < + > and < - > keys to manually select an IRQ for a given device, or select Default to allow the BIOS to select an IRQ value at system startup.

Serial Communication Screen

Option	Description
Serial Communication (On without Console Redirection default)	Selects whether the serial communication devices (Serial Device 1 and Serial Device 2) are enabled in BIOS. BIOS console redirection can also be enabled and the port address used can be specified. Options are On without Console Redirection , On with Console Redirection via COM1 , On with Console Redirection via COM2 , and Off .
Serial Port Address (Serial Device 1= COM1, Serial Device2= COM2 default)	Sets the serial port addresses for the two serial devices. NOTE: Only Serial Device 2 can be used for Serial Over LAN (SOL). To use console redirection by SOL, configure the same port address for console redirection and the serial device.
External Serial Connector (Serial Device1 default)	Specifies whether Serial Device 1 , Serial Device 2 , or Remote Access Device has access to the external serial connector. NOTE: Only Serial Device 2 can be used for SOL. To use console redirection by SOL, configure the same port address for console redirection and the serial device.
Failsafe Baud Rate (115200 default)	Displays the failsafe baud rate used for console redirection. BIOS attempts to determine the baud rate automatically. This failsafe baud rate is used only if the attempt fails. This rate should not be adjusted.
Remote Terminal Type (VT 100/VT220 default)	Sets the remote console terminal type, either VT100/VT220 or ANSI .
Redirection After Boot (Enabled default)	Enables or disables BIOS console redirection when the operating system is loaded.

Power Management Screen

Option	Description
Power Management (OS Control default)	<p data-bbox="390 296 941 408">Options are OS Control, Custom, or Maximum Performance. For all but the Custom setting, the BIOS pre-configures the power settings on this screen as follows:</p> <ul data-bbox="398 424 958 695" style="list-style-type: none"><li data-bbox="398 424 958 632">• OS Control sets the CPU power to OS DBPM, the fan power to Minimum Power, and the memory power to Maximum Performance. In this setting, all processor performance information is passed from the system BIOS to the operating system for control. The operating system sets the processor performance based on processor utilization.<li data-bbox="398 639 913 695">• Maximum Performance sets all fields to Maximum Performance.
CPU Power and Performance Management	<p data-bbox="390 783 908 839">Options are OS DBPM, Maximum Performance, or Minimum Power.</p>
Fan Power and Performance Management	<p data-bbox="390 887 958 911">Options are Maximum Performance or Minimum Power.</p>
Memory Power and Performance Management	<p data-bbox="390 991 869 1046">Options are Maximum Performance, a specified frequency, or Minimum Power.</p>

System Security Screen

Option	Description
TPM Security (Off default)	<p>Sets the reporting of the Trusted Platform Module (TPM) in the system.</p> <p>If Off, the presence of the TPM is not reported to the operating system.</p> <p>If On with Pre-boot Measurements, the system reports the TPM to the operating system and stores the pre-boot measurements to the TPM during POST.</p> <p>If On without Pre-boot Measurements, the system reports the TPM to the operating system and bypasses pre-boot measurements.</p>
TPM Status	<p>When set to Disabled, the TPM is disabled. When set to Deactivated, the TPM is deactivated.</p>
TPM Activation	<p>When set to Activate, the TPM is enabled to default settings. When set to Deactivate, the TPM is disabled. The No Change state initiates no action. The operational state of the TPM remains unchanged (all user settings for the TPM are preserved).</p> <p>NOTE: This field is read-only when TPM Security is set to Off.</p>
TPM Clear	<p> CAUTION: Clearing the TPM will lose all encryption keys in the TPM. This option prevents booting to the operating system and results in data loss if the encryption keys cannot be restored. Back up the TPM keys prior to enabling this option.</p> <p>When set to Yes, all TPM contents are cleared.</p> <p>NOTE: This field is read-only when TPM Security is set to Off.</p>
System Password (Not Enabled default)	<p>Displays the current status of the password security feature and allows a new system password assignment and verification.</p> <p>NOTE: For more information, see "Using the System Password" on page 40.</p>

Option	Description
Setup Password (Not Enabled default)	Restricts access to the System Setup program by using a setup password. NOTE: For more information, see "Using the Setup Password" on page 42.
Password Status (Unlocked default)	When Setup Password is assigned and this field is Locked , the system password cannot be changed or disabled at system start-up. NOTE: For more information, see "Using the System Password" on page 40.
Set Setup Password	Allows a new setup password assignment.
Set System Password	Allows a new system password assignment.
Power Button (Enabled default)	If Enabled , the power button can turn the system's power off and on. On an ACPI-compliant operating system, the system performs an orderly shutdown before power is turned off. When Disabled , the button can only turn on system power.
AC Power Recovery (Last default)	Determines how the system reacts when power is restored. If set to Last , the system returns to the last power state. On turns on the system after power is restored. Off allows the system to remain off after power is restored.
AC Power Recovery Delay (Immediate default)	Determines how the system supports the staggering of power up after the AC power has been restored to the system. Options are: <ul style="list-style-type: none"> • Immediate—No delay for power up. • Random—A random delay of 30 to 240 seconds for iDRAC6 or 45 to 240 seconds for BMC. • User Defined—The system delays power up based on the defined amount. The defined range is 30 to 240 seconds for iDRAC6 or 45 to 240 seconds for BMC .

Exit Screen

Press < Esc > to exit the System Setup program. The following messages are displayed on the **Exit** screen:

- Saving Changes and Exit
- Discarding Changes and Exit
- Return to Setup

Entering the Boot Manager

 **NOTE:** Operating systems must be 64-bit UEFI-compatible (for example, Microsoft Windows Server 2008 x64 version) to be installed from the UEFI boot mode. DOS and 32-bit operating systems can only be installed from the BIOS boot mode.

 **NOTE:** The Boot Mode must be set to **UEFI** in the System Setup program to access the Boot Manager.

The Boot Manager enables you to:

- Add, delete, and arrange boot options
- Access the System Setup program and BIOS-level boot options without rebooting

To enter the Boot Manager:

- 1 Turn on or restart your system.

2 Press <F11> after you see the following message:

<F11> = Boot Manager



NOTE: The system will not respond until the USB keyboard is active.

If your operating system begins to load before you press <F11>, allow the system to finish booting, and then restart your system and try again.

Using the Boot Manager Navigation Keys

Keys	Action
Up arrow	Moves to and highlights the previous field.
Down arrow	Moves to and highlights the next field.
< Enter >	Selects the field and sub-menu.
< Esc >	Refreshes the Boot Manager screen, or returns to the Boot Manager screen from the other program screens.
< F1 >	Displays the Boot Manager help file.

Boot Manager Screen

Option	Description
Continue Normal Boot	The system attempts to boot to devices starting with the first item in the boot order. If the boot attempt fails, the system will continue with the next item in the boot order until the boot is successful or no more boot options are found.
Select Boot Mode	Displays the list of available boot options (marked with asterisks). Select the boot option you wish to use and press Enter .
Boot Settings	Enables you to add, delete, enable, or disable boot options; change boot order; or execute a one-time boot option.
System Utilities	Enables you to access the System Setup program, System Services (Dell Unified Server Configurator [USC]), Diagnostics, and BIOS-level boot options.

Boot Settings Screen

Boot Mode: BIOS

Option	Description
Set Boot Order	Sets the order of the boot option list.
Set Legacy Floppy Drive Order	Sets the floppy drive boot priority.
Set Legacy Hard Disk Drive Order	Sets the hard-drive boot priority.
Set Legacy CD-ROM Drive Order	Sets the CD-ROM boot priority.
Set Legacy NET Drive Order	Sets the network device boot priority.
Set Legacy BEV Drive Order	Sets the Bootstrap Entry Vector (BEV) boot priority.

NOTE: Only the first device under Legacy Drive is displayed in the *Set Boot Order* option.

Boot Mode: UEFI

Option	Description
Add Boot Option	Adds a new boot option.
Delete Boot Option	Deletes an existing boot option.
Enable/Disable Boot Option	Disables and enables a boot option in the boot option list.
Boot From File	Sets a one-time boot option not included in the boot option list.
Set Boot Order	Sets the order of the boot option list.

System Utilities Screen

Option	Description
System Setup	Accesses the System Setup program without rebooting.
System Services	Restarts the system and accesses the Dell USC, which allows you to run utilities such as system diagnostics.
Reset System	Restarts the system.

System and Setup Password Features

 **NOTE:** For a forgotten password, see "Disabling a Forgotten Password" on page 118.

Your system is shipped without the system password feature enabled. Operate the system only with system password protection.

 **CAUTION:** The password features provide a basic level of security for the data on your system.

 **CAUTION:** Anyone can access the data stored on your system if the system is running and unattended.

Using the System Password

When a system password is assigned, the system prompts for the system password after the system starts and only those with the password have full use of the system.

Assigning a System Password

Before assigning a system password, enter the System Setup program and check the **System Password** option.

When a system password is assigned, **System Password** is **Enabled**. If **Password Status** is **Unlocked**, you can change the system password. If **Locked**, you cannot change the system password. Disabling the password jumper on the system board sets **System Password** to **Disabled**, and you cannot change or enter a new system password.

When a system password is not assigned and the password jumper on the system board is in the enabled position, **System Password** is **Not Enabled** and **Password Status** is **Unlocked**.

To assign a system password:

- 1 Verify that **Password Status** is **Unlocked**.
- 2 Highlight the **System Password** option and press < Enter > .
- 3 Type your new system password.

You can use up to 32 characters in your password.

As you type, placeholders appear in the field.

The password assignment is not case-sensitive. Certain key combinations are invalid. To erase a character, press < Backspace > .

 **NOTE:** To escape from the field without assigning a system password, press <Enter> to move to another field, or press <Esc> prior to completing step 5.

4 Press < Enter > .

5 To confirm your password, type it a second time and press < Enter > .

System Password changes to **Enabled**. Exit the System Setup program and begin using your system.

6 Either reboot the system now for the password protection to take effect or continue working.

 **NOTE:** Password protection does not take effect until the system reboots.

Using Your System Password to Secure Your System

 **NOTE:** If you have assigned a setup password (see "Using the Setup Password" on page 42), the system accepts your setup password as an alternate system password.

1 Turn on or reboot your system by pressing < Ctrl > < Alt > < Delete > .

2 Type your password and press < Enter > .

When **Password Status** is **Locked**, you must type the password and press < Enter > when prompted at reboot.

If an incorrect system password is entered, the system displays a message and prompts you to re-enter your password. You have three attempts to enter the correct password. After the third unsuccessful attempt, the system displays an error message that the system has halted and will shut down.

Even after you shut down and restart the system, the error message continues to be displayed until the correct password is entered.

 **NOTE:** You can use the **Password Status** option in conjunction with the **System Password** and **Setup Password** options to protect your system from unauthorized changes.

Deleting or Changing an Existing System Password

- 1 Enter the System Setup program and select the **System Security**.
- 2 Highlight **Setup Password**, press < Enter > to access the setup password window. Press < Enter > twice to clear the existing setup password.
- 3 The setting changes to **Not Enabled**.
- 4 If you want to assign a new setup password, perform the steps in "Assigning a Setup Password" on page 42.

Using the Setup Password

Assigning a Setup Password

You can assign a setup password only when the **Setup Password** is **Not Enabled**. To assign a setup password, highlight the **Setup Password** option and press the < + > or < - > key. The system prompts you to enter and verify the password.



NOTE: The setup password can be the same as the system password. If the two passwords are different, the setup password can be used as an alternate system password. The system password cannot be used in place of the setup password.

You can use up to 32 characters in your password.

As you type, placeholders appear in the field.

The password assignment is not case-sensitive. Certain key combinations are invalid. To erase a character, press < Backspace > .

When you verify the password, the **Setup Password** changes to **Enabled**. The next time you enter the System Setup program, the system prompts you for the setup password.

A change to the **Setup Password** option becomes effective immediately (restarting the system is not required).

Operating With a Setup Password Enabled

If **Setup Password** is **Enabled**, you must enter the correct setup password before modifying most of the System Setup options.

If you do not enter the correct password in three attempts, the system lets you view, but not modify, the System Setup screens. The following options are exceptions: If **System Password** is not **Enabled** and is not locked through the **Password Status** option, you can assign a system password. You cannot disable or change an existing system password.



NOTE: You can use the **Password Status** option in conjunction with the **Setup Password** option to protect the system password from unauthorized changes.

Deleting or Changing an Existing Setup Password

- 1 Enter the System Setup program and select the **System Security**.
- 2 Highlight **Setup Password**, press < Enter > to access the setup password window. Press < Enter > twice to clear the existing setup password.

The setting changes to **Not Enabled**.

- 3 If you want to assign a new setup password, perform the steps in "Assigning a Setup Password" on page 42.

Embedded System Management

The Dell USC is an embedded utility that enables systems and storage management tasks from an embedded environment throughout the server's lifecycle.

The Dell USC can be started during the boot sequence and can function independently of the operating system.



NOTE: Certain platform configurations may not support the full set of features provided by Dell USC.

The following features of Dell USC are supported on systems with Baseboard Management Controller (BMC):

- Installing an operating system
- Running diagnostics to validate the memory, I/O devices, processor, physical disks, and other peripherals

When an optional iDRAC6 Express card is installed, Dell USC provides the following additional features:

- Downloading and applying firmware updates
- Configuring hardware and firmware

For more information about setting up Dell USC, configuring hardware and firmware, and deploying the operating system, see the Unified Server Configurator documentation at support.dell.com/manuals.

Baseboard Management Controller Configuration

The BMC enables configuring, monitoring, and recovery of systems remotely. The BMC provides the following features:

- Enables fault logging and SNMP alerting
- Provides access to system event log and sensor status
- Allows control of system functions including power on and off
- Functions independently of the system's power state or the system's operating system
- Provides text console redirection for system setup, text-based utilities, and operating system consoles



NOTE: To remotely access the BMC through the integrated NIC, you must connect the network connection to integrated NIC1.

For additional information on using BMC, see the documentation for the BMC and systems management applications at support.dell.com/manuals.

Entering the BMC Setup Module

- 1 Turn on or restart your system.
- 2 Press < Ctrl> < E> when prompted after POST.

If your operating system begins to load before you press < Ctrl> < E> , allow the system to finish booting, and then restart your system and try again.

iDRAC6 Configuration Utility

The iDRAC6 Configuration Utility is a pre-boot configuration environment that allows you to view and set parameters for the iDRAC6 and for the managed server.

The iDRAC6 Configuration Utility provides the following features:

- Enables fault logging and SNMP alerting
- Provides access to system event log and sensor status
- Allows control of system functions including power on and off
- Functions independently of the system's power state or the system's operating system
- Provides text console redirection for system setup, text-based utilities, and operating system consoles.

In addition, the iDRAC6 Configuration Utility enables you to:

- Configure, enable, or disable the iDRAC6 local area network through the dedicated iDRAC6 Enterprise card port or the embedded NIC1.
- Enable or disable IPMI over LAN.
- Enable a LAN Platform Event Trap (PET) destination.
- Attach or detach the Virtual Media devices.
- Change the administrative user name and password and manage user privileges.
- View System Event Log (SEL) messages or clear messages from the log.

For additional information on using iDRAC6, see the documentation for iDRAC6 and systems management applications at support.dell.com/manuals.

Entering the iDRAC6 Configuration Utility

- 1 Turn on or restart your system.
- 2 Press < Ctrl> < E> when prompted during POST.

If your operating system begins to load before you press < Ctrl> < E> , allow the system to finish booting, and then restart your system and try again.

Installing System Components

Recommended Tools

- Key to the system keylock
- #1 and #2 Phillips screwdrivers
- Wrist grounding strap

Inside the System

⚠ CAUTION: Many repairs may only be done by a certified service technician. You should only perform troubleshooting and simple repairs as authorized in your product documentation, or as directed by the online or telephone service and support team. Damage due to servicing that is not authorized by Dell is not covered by your warranty. Read and follow the safety instructions that came with the product.

Figure 5-1. Inside the System

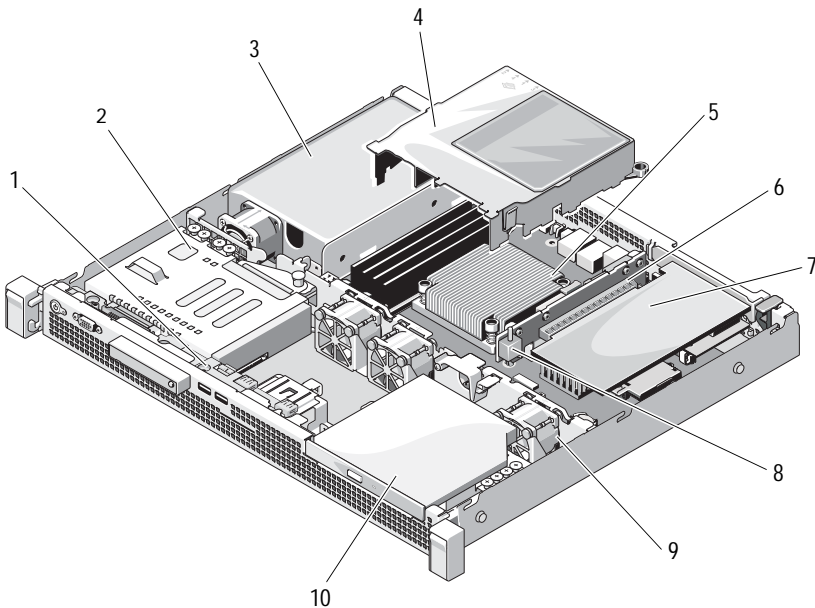

- | | | | |
|---|-------------------------|----|--------------------------|
| 1 | control panel board | 2 | hard drives (2) |
| 3 | power supply | 4 | cooling shroud |
| 5 | heat sink/processor | 6 | expansion-card riser |
| 7 | expansion card | 8 | chassis intrusion switch |
| 9 | system cooling fans (3) | 10 | optical drive |

Front Bezel (Optional)

Removing the Front Bezel

- 1 Using the system key, unlock the front bezel (if locked).
- 2 Lift up the release latch next to the keylock.
- 3 Rotate the left end of the bezel away from the front panel.
- 4 Unhook the right end of the bezel and pull the bezel away from the system.

Figure 5-2. Removing and Installing the Front Bezel

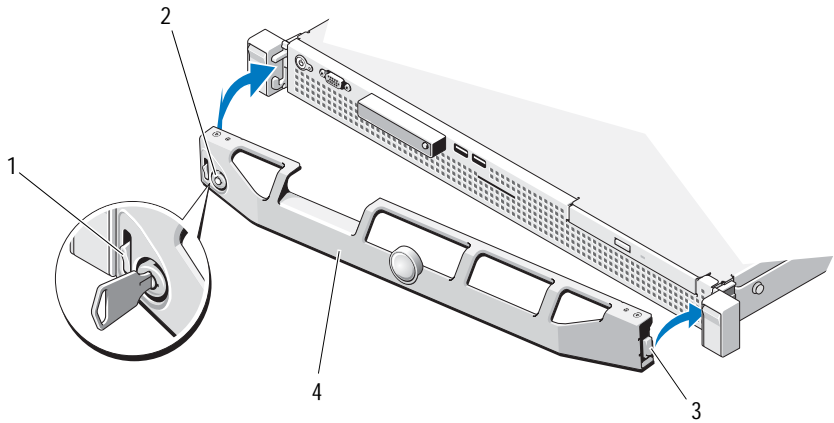

- | | | | |
|---|---------------|---|-------------|
| 1 | release latch | 2 | keylock |
| 3 | hinge tab | 4 | front bezel |

Installing the Front Bezel

- 1 Hook the right end of the bezel onto the chassis.
- 2 Fit the free end of the bezel onto the system.
- 3 Secure the bezel with the keylock. See Figure 5-2.

Opening and Closing the System



WARNING: Whenever you need to lift the system, get others to assist you. To avoid injury, do not attempt to lift the system by yourself.



CAUTION: Many repairs may only be done by a certified service technician. You should only perform troubleshooting and simple repairs as authorized in your product documentation, or as directed by the online or telephone service and support team. Damage due to servicing that is not authorized by Dell is not covered by your warranty. Read and follow the safety instructions that came with the product.

Opening the System

- 1 Turn off the system and attached peripherals, and disconnect the system from the electrical outlet.
- 2 Rotate the latch release lock counter clockwise to the unlocked position. See Figure 5-3.
- 3 Grasp the cover on both sides while pressing your thumbs on the latch release lock and the indent, carefully slide the cover toward the back of the system, and lift it away from the system. See Figure 5-3.

Figure 5-3. Opening and Closing the System

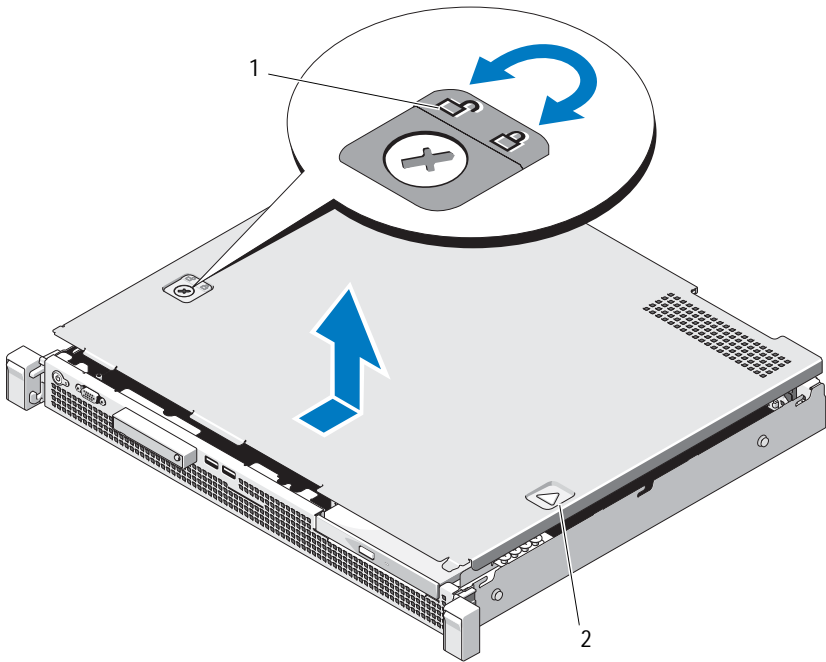

1 latch release lock

2 indent

Closing the System

- 1 Align the cover with the left and right edges of the system and offset it slightly towards the back of the system, so that the pins on the inner edge of the cover are aligned with the chassis hooks. See Figure 5-3.
- 2 Slide the cover toward the front of the chassis till it locks in position.
- 3 Rotate the latch release lock in a clockwise direction to secure the cover.

Optical Drive (Optional)

An optional slimline DVD-ROM or DVD+/-RW optical drive slides into the front panel and connects to the SATA controller on the system board.

 **NOTE:** DVD devices are data only.

Removing an Optical Drive

 **CAUTION:** Many repairs may only be done by a certified service technician. You should only perform troubleshooting and simple repairs as authorized in your product documentation, or as directed by the online or telephone service and support team. Damage due to servicing that is not authorized by Dell is not covered by your warranty. Read and follow the safety instructions that came with the product.

- 1 If installed, remove the front bezel. See "Removing the Front Bezel" on page 49.
- 2 Turn off the system, including any attached peripherals, and disconnect the system from its electrical outlet.
- 3 Open the system. See "Opening the System" on page 50.
- 4 Press the release latch. Lift and angle the drive to release it from the notch on the metal standoffs. See Figure 5-4.
- 5 Disconnect the power/data cable from the back of the optical drive.
Note the routing of the power and data cables underneath the tabs on the chassis as you remove them from the system board and drive. You must route these cables properly when you replace them to prevent them from being pinched or crimped.
- 6 Lift the drive out of the chassis. See Figure 5-4.
- 7 If you are not replacing the optical drive, remove the drive from the drive bay (see Figure 5-4) and insert the filler panel into the drive bay (see Figure 5-5).
- 8 Close the system. See "Closing the System" on page 51.
- 9 Reconnect the system to its electrical outlet and turn the system on, including any attached peripherals.
- 10 If applicable, replace the front bezel. See "Installing the Front Bezel" on page 49.

Figure 5-4. Removing and Installing the Optical Drive

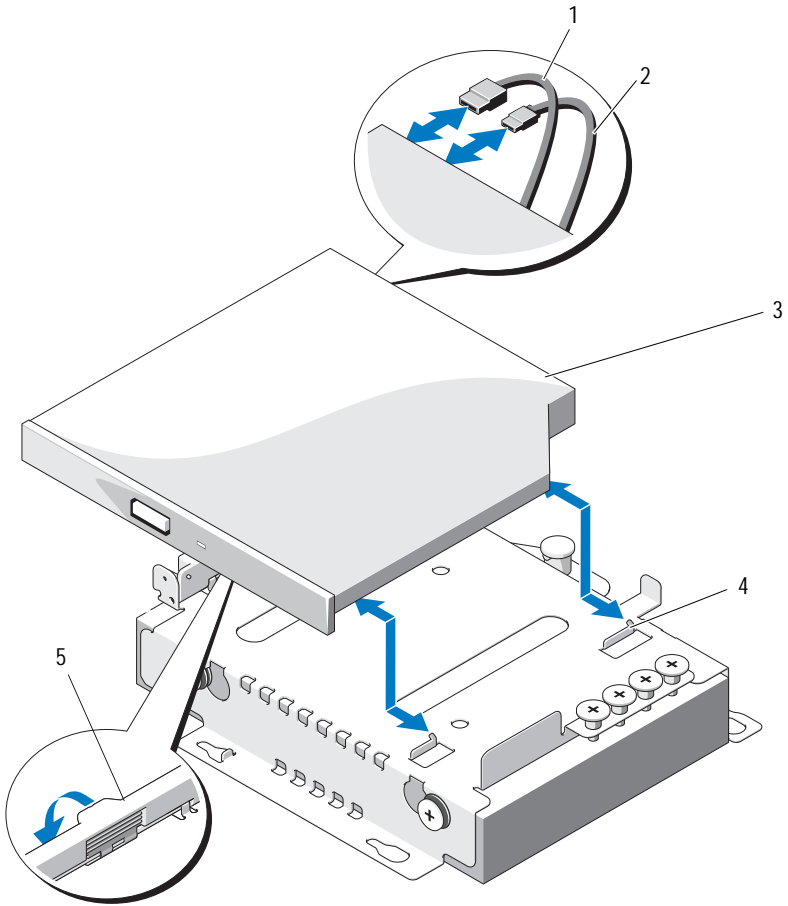

- | | | | |
|---|---------------|---|----------------------------------|
| 1 | data cable | 2 | power cable |
| 3 | optical drive | 4 | metal standoffs with notches (2) |
| 5 | release latch | | |

Installing an Optical Drive

 **CAUTION:** Many repairs may only be done by a certified service technician. You should only perform troubleshooting and simple repairs as authorized in your product documentation, or as directed by the online or telephone service and support team. Damage due to servicing that is not authorized by Dell is not covered by your warranty. Read and follow the safety instructions that came with the product.

- 1 If installed, remove the front bezel. See "Removing the Front Bezel" on page 49.
- 2 Turn off the system, including any attached peripherals, and disconnect the system from its electrical outlet.
- 3 Open the system. See "Opening the System" on page 50.
- 4 If the drive bay is empty, remove the filler panel. See Figure 5-5.
- 5 Connect the power/data cable to the back of the optical drive.
You must route these cables properly underneath the tab on the system chassis to prevent them from being pinched or crimped.
- 6 Press down on the release latch and place the optical drive in position.
- 7 Align the two notches on the metal standoffs with the holes on the optical drive. See Figure 5-4.
- 8 Slide the optical drive into the notches and seat it firmly.
- 9 Push the release latch back to position.
- 10 Close the system. See "Closing the System" on page 51.
- 11 If applicable, replace the front bezel. See "Installing the Front Bezel" on page 49.
- 12 Reconnect the system to its electrical outlet and turn the system on, including any attached peripherals.

Filler Panel

Depending on the configuration of your system, a filler panel may be installed in the 5.25-inch optical drive bay at the front of the system. Filler panels are essential for airflow efficiency and for electromagnetic interference protection. Before installing an optical drive, the corresponding filler panel must first be removed.

Removing a Filler Panel

- 1 Turn off the system and attached peripherals, and disconnect the system from the electrical outlet.
- 2 Open the system. See "Opening the System" on page 50.
- 3 If installed, remove the front bezel. See "Removing the Front Bezel" on page 49.
- 4 Pull the filler panel away from the chassis.

Figure 5-5. Removing and Installing a Filler Panel

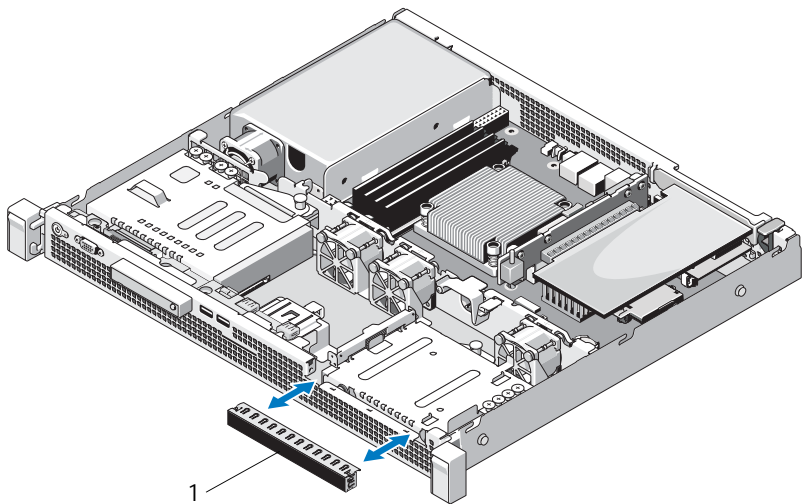

- 1 filler panel

Installing a Filler Panel

- 1 Slide the filler panel into the bay until it clicks into place. See Figure 5-5.
- 2 Replace the front bezel. See "Installing the Front Bezel" on page 49.
- 3 Close the system. See "Closing the System" on page 51.

Hard Drives

Your system supports up to two 3.5-inch (SAS or SATA) hard drives. The hard drives are installed internally in the system (see Figure 5-1) and connected to the system board.

Removing a 3.5-Inch Hard Drive

 **CAUTION:** Many repairs may only be done by a certified service technician. You should only perform troubleshooting and simple repairs as authorized in your product documentation, or as directed by the online or telephone service and support team. Damage due to servicing that is not authorized by Dell is not covered by your warranty. Read and follow the safety instructions that came with the product.

- 1 Turn off the system and attached peripherals, and disconnect the system from the electrical outlet.
- 2 Open the system. See "Opening the System" on page 50.
- 3 Disconnect the power/data cable from the hard drive.
- 4 To remove HDD1, remove the optical drive (if present) mounted above the hard-drive carrier. See "Removing an Optical Drive" on page 52.
- 5 Lift the release pin and slide the hard-drive carrier away from the chassis. See Figure 5-6.
- 6 Lift the hard-drive carrier away from the system.

Figure 5-6. Removing and Installing a 3.5-Inch Hard Drive

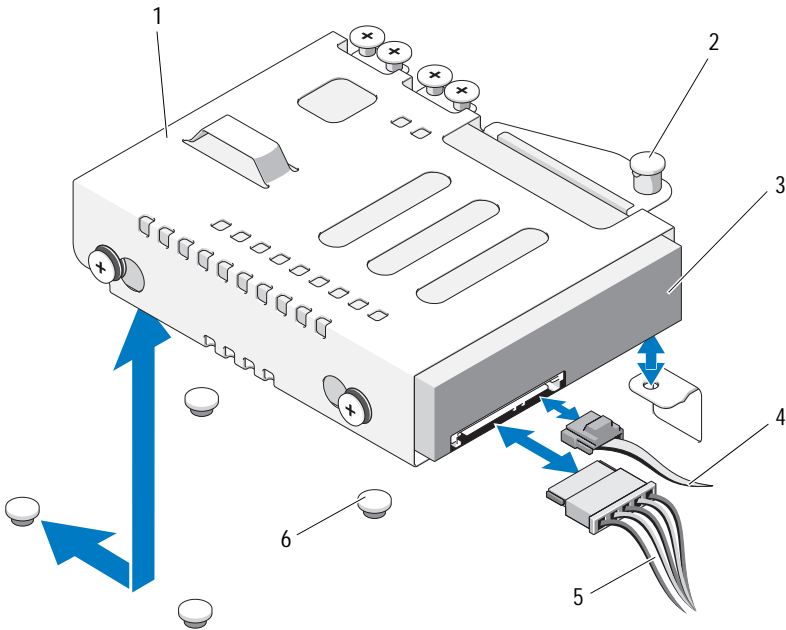

- | | | | |
|---|--------------------|---|------------------|
| 1 | hard-drive carrier | 2 | release pin |
| 3 | hard drive | 4 | data cable |
| 5 | power cable | 6 | chassis tabs (4) |

 **NOTE:** If you are not replacing the hard drive, remove the drive from the hard-drive carrier (see "Removing a 3.5-Inch Hard Drive From a Hard-Drive Carrier" on page 59) and replace the empty hard-drive carrier back into the drive bay.

- 7 If you have removed or replaced HDD1, replace the optical drive (if present) mounted above the hard-drive carrier. See "Installing an Optical Drive" on page 54.
- 8 Close the system. See "Closing the System" on page 51.
- 9 Reconnect the system to its electrical outlet and turn the system on, including any attached peripherals.

Installing a 3.5-Inch Hard Drive

 **CAUTION:** Many repairs may only be done by a certified service technician. You should only perform troubleshooting and simple repairs as authorized in your product documentation, or as directed by the online or telephone service and support team. Damage due to servicing that is not authorized by Dell is not covered by your warranty. Read and follow the safety instructions that came with the product.

- 1 Turn off the system and attached peripherals, and disconnect the system from the electrical outlet.
- 2 Open the system. See "Opening the System" on page 50.
- 3 To install HDD1, remove the optical drive (if present) mounted above the hard-drive carrier. See "Removing an Optical Drive" on page 52.
- 4 Install the hard drive into the carrier. See "Installing a 3.5-Inch Hard Drive Into a Hard-Drive Carrier" on page 60.
- 5 Align the four slots under the hard-drive carrier with the four tabs on the chassis. Slide the hard-drive carrier toward the chassis wall till it snaps into place. See Figure 5-7.

If you replaced HDD1, reinstall the optical drive (if present) above the HDD1 bracket. See "Installing an Optical Drive" on page 54.

- 6 Connect the power/data cable to the hard drive:
 - If connecting to the integrated SATA controller (SATA hard drives only), connect the SATA data cable to the SATA connector on the system board. See Figure 8-1.
 - If connecting to a SAS RAID controller card (SAS or SATA hard drives), connect the data cable to the connector on the card edge. For information on installing a SAS controller card, see "Installing an Expansion Card" on page 62.
- 7 Close the system. See "Closing the System" on page 51.
- 8 Reconnect the system to the electrical outlet and turn on the system and attached peripherals.

- 9 Enter the System Setup program and ensure that the hard drive's controller is enabled. See "Entering the System Setup Program" on page 26.
- 10 Exit the System Setup program and reboot the system.
See the documentation that came with the hard drive for instructions on installing any software required for drive operation.
- 11 Close the system. See "Closing the System" on page 51.
- 12 Reconnect the system to its electrical outlet and turn the system on, including any attached peripherals.

Removing a 3.5-Inch Hard Drive From a Hard-Drive Carrier

Remove the screws from the slide rails on the hard-drive carrier and separate the hard drive from the hard-drive carrier. See Figure 5-7.

Figure 5-7. Removing a 3.5-Inch Hard Drive From a Hard-Drive Carrier

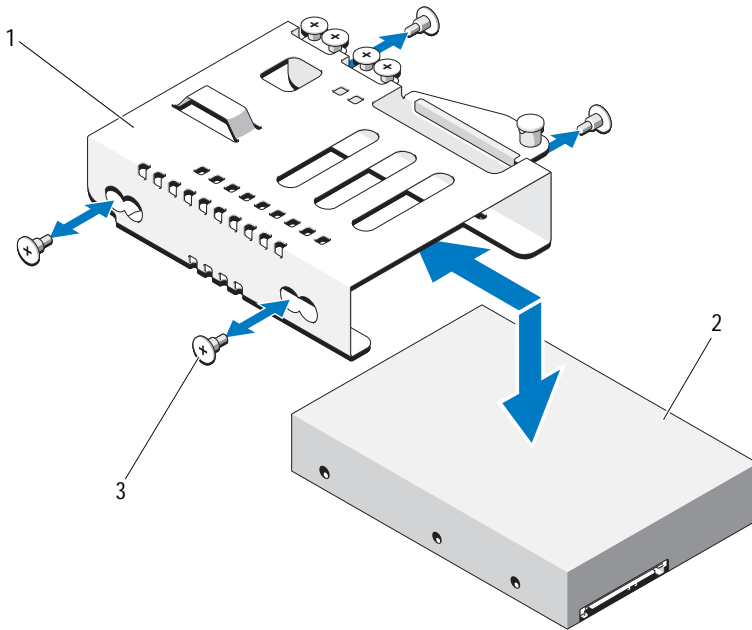

1 hard-drive carrier

2 hard drive

3 screws (4)*

*Screws are supplied along with the hard drives ordered from Dell.

Installing a 3.5-Inch Hard Drive Into a Hard-Drive Carrier

- 1 Insert the hard drive into the hard-drive carrier. See Figure 5-7.
- 2 Align the holes on the hard drives with the set of holes on the hard-drive carrier.
- 3 Attach the screws to secure the hard drive to the hard-drive carrier.

Expansion Card

Expansion Card Installation Guidelines

Your system supports one PCIe Generation 2 expansion card installed on an expansion-card riser.

- The expansion-card slot supports full-height and half-length cards.
- The expansion-card slot is not hot-swappable.

Removing an Expansion Card

 **CAUTION:** Many repairs may only be done by a certified service technician. You should only perform troubleshooting and simple repairs as authorized in your product documentation, or as directed by the online or telephone service and support team. Damage due to servicing that is not authorized by Dell is not covered by your warranty. Read and follow the safety instructions that came with the product.

- 1 Turn off the system, including any attached peripherals, and disconnect the system from the electrical outlet.
- 2 Open the system. See "Opening the System" on page 50.
- 3 Disconnect all cables from the card.
- 4 Lift and rotate the expansion-card latch. See Figure 5-8.
- 5 Grasp the expansion card by its edges and carefully remove it from the connector on the expansion-card riser.
- 6 If you are removing the card permanently, install a metal filler bracket over the empty expansion-card slot opening and close the expansion-card latch.



NOTE: You must install a filler bracket over an empty expansion slot to maintain Federal Communications Commission (FCC) certification of the system. The brackets also keep dust and dirt out of the system and aid in proper cooling and airflow inside the system.

- 7 Close the system. See "Closing the System" on page 51.
- 8 Reconnect the system to its electrical outlet and turn the system on, including any attached peripherals.

Installing an Expansion Card



CAUTION: Many repairs may only be done by a certified service technician. You should only perform troubleshooting and simple repairs as authorized in your product documentation, or as directed by the online or telephone service and support team. Damage due to servicing that is not authorized by Dell is not covered by your warranty. Read and follow the safety instructions that came with the product.

- 1 Unpack the expansion card and prepare it for installation.
For instructions, see the documentation accompanying the card.
- 2 Turn off the system, including any attached peripherals, and disconnect the system from the electrical outlet.
- 3 Open the system. See "Opening the System" on page 50.
- 4 Lift and rotate the expansion-card latch and remove the filler bracket. See Figure 5-8.
- 5 Holding the expansion card by its edges, position the card so that the card-edge connector aligns with the expansion-card connector on the expansion-card riser.
- 6 Insert the card-edge connector firmly into the expansion-card connector until the card is fully seated.
- 7 Close the expansion-card latch. See Figure 5-8.

Figure 5-8. Removing and Installing an Expansion Card

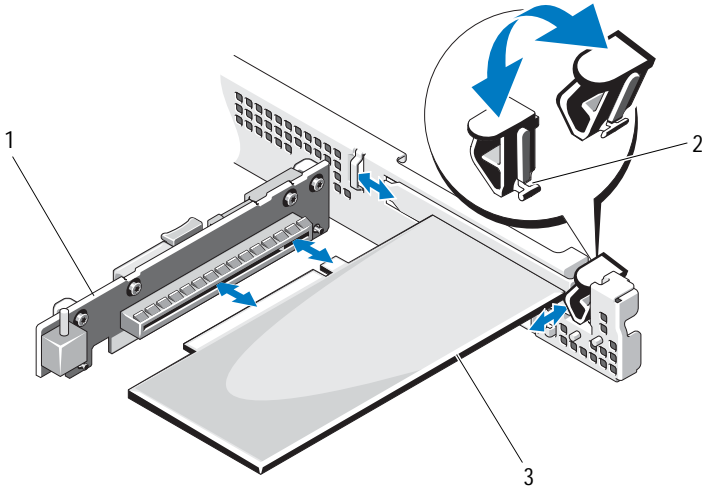

- 1 expansion-card riser
- 2 expansion-card latch
- 3 expansion card

- 8 Connect any cables to the expansion card.
- 9 Close the system. See "Closing the System" on page 51.
- 10 Reconnect the system to its electrical outlet and turn the system on, including any attached peripherals

Expansion-Card Riser

The system's expansion-card riser supports an x16 link Generation 2 PCIe expansion card.

Removing an Expansion-Card Riser

△ CAUTION: Many repairs may only be done by a certified service technician. You should only perform troubleshooting and simple repairs as authorized in your product documentation, or as directed by the online or telephone service and

support team. Damage due to servicing that is not authorized by Dell is not covered by your warranty. Read and follow the safety instructions that came with the product.

- 1 Turn off the system, including any attached peripherals, and disconnect the system from the electrical outlet.
- 2 Open the system. See "Opening the System" on page 50.
- 3 If installed, remove the expansion card from the expansion slot. See "Removing an Expansion Card" on page 61.
- 4 To remove the expansion-card riser, press the release tab and lift the expansion-card riser from the chassis. See Figure 5-9.

Figure 5-9. Removing and Installing an Expansion-Card Riser

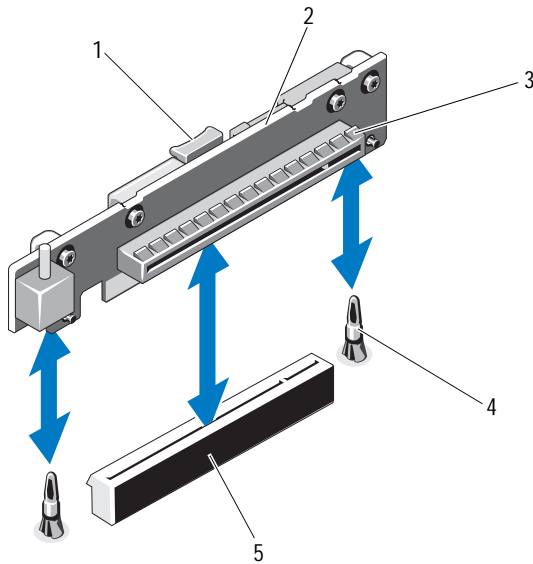

- | | | | |
|---|--------------------------------|---|-----------------------|
| 1 | release tab | 2 | expansion-card riser |
| 3 | expansion-card slot | 4 | riser guide posts (2) |
| 5 | expansion-card riser connector | | |

Installing an Expansion-Card Riser

 **CAUTION:** Many repairs may only be done by a certified service technician. You should only perform troubleshooting and simple repairs as authorized in your product documentation, or as directed by the online or telephone service and support team. Damage due to servicing that is not authorized by Dell is not covered by your warranty. Read and follow the safety instructions that came with the product.

- 1 Align the expansion-card riser with the riser guide posts on the system board. See Figure 5-9.
- 2 Lower the expansion-card riser into place until the expansion-card riser connector is fully seated.
- 3 If applicable, reinstall the expansion card. See "Installing an Expansion Card" on page 62.
- 4 Close the system. See "Closing the System" on page 51.
- 5 Reconnect the system to its electrical outlet and turn the system on, including any attached peripherals.

Internal USB Memory Key

The USB memory key can be used as a boot device, security key, or mass storage device. To use the internal USB connector, the **Internal USB Port** option must be enabled in the **Integrated Devices** screen of the System Setup program. See "Integrated Devices Screen" on page 31.

To boot from the USB memory key, you must configure the USB memory key with a boot image and then specify the USB memory key in the boot sequence in the System Setup program. See "Boot Settings Screen" on page 31. For information on creating a bootable file on the USB memory key, see the user documentation that accompanied the USB memory key.

 **CAUTION:** Many repairs may only be done by a certified service technician. You should only perform troubleshooting and simple repairs as authorized in your product documentation, or as directed by the online or telephone service and support team. Damage due to servicing that is not authorized by Dell is not covered by your warranty. Read and follow the safety instructions that came with the product.

NOTE: To avoid interference with other components, the maximum allowable dimensions of the USB key are 24 mm (0.94 in) wide x 79 mm (3.11 in) long x 8.6 mm (0.33 in) high.

- 1 Turn off the system, including any attached peripherals, and disconnect the system from the electrical outlet.
- 2 Open the system. See "Opening the System" on page 50.
- 3 Locate the USB connector on the control panel board. See Figure 5-20.
- 4 Insert the USB memory key into the USB connector.
- 5 Close the system. See "Closing the System" on page 51.
- 6 Reconnect the system to its electrical outlet and turn the system on, including any attached peripherals.

Figure 5-10. Removing and Installing a USB Memory Key

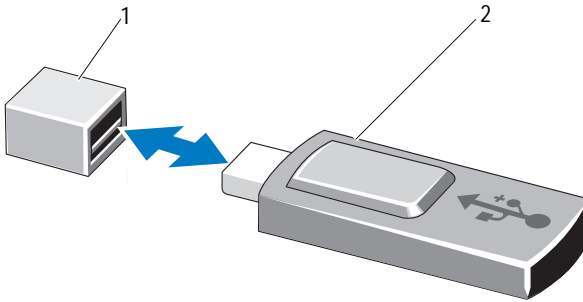

1 USB memory key connector

2 USB memory key

Cooling Shroud

The cooling shroud covers the processor, heat sink, and memory modules, and provides airflow to these components. Airflow is facilitated by the cooling fan modules, which are positioned directly behind the cooling shroud.

Removing the Cooling Shroud



-  **WARNING:** The memory modules and heat sink can get very hot during normal operation. Ensure that the memory modules and heat sink have had sufficient time to cool before you touch it.
-  **CAUTION:** Many repairs may only be done by a certified service technician. You should only perform troubleshooting and simple repairs as authorized in your product documentation, or as directed by the online or telephone service and support team. Damage due to servicing that is not authorized by Dell is not covered by your warranty. Read and follow the safety instructions that came with the product.
-  **CAUTION:** Never operate your system with the cooling shroud removed. The system may get overheated quickly, resulting in shutdown of the system and loss of data.
 - 1 Turn off the system, including any attached peripherals, and disconnect the system from the electrical outlet.
 - 2 Open the system. See "Opening and Closing the System" on page 50.
 - 3 Hold the touch points and gently lift the shroud straight up and away from the chassis. See Figure 5-11.

Figure 5-11. Removing and Installing the Cooling Shroud



1 touch points (2)

2 cooling shroud

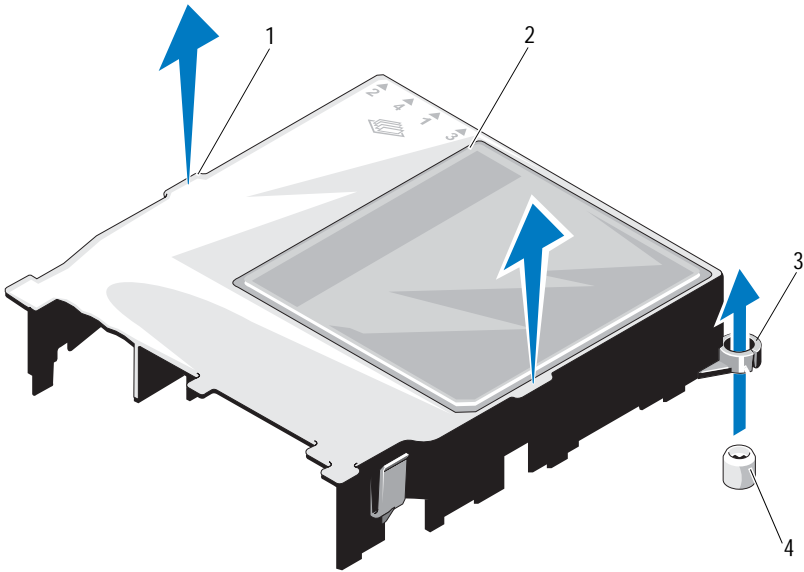
3 guide slots (2)

4 guide screws (2)

Installing the Cooling Shroud

 **CAUTION:** Many repairs may only be done by a certified service technician. You should only perform troubleshooting and simple repairs as authorized in your product documentation, or as directed by the online or telephone service and support team. Damage due to servicing that is not authorized by Dell is not covered by your warranty. Read and follow the safety instructions that came with the product.

- 1 Position the cooling shroud by aligning the guide slots with the guide screws on the system board. See Figure 5-11.
- 2 Push the cooling shroud down until all edges are secured to the system board.
- 3 Close the system. See "Opening and Closing the System" on page 50.

System Memory

Your system supports single- and dual-rank DDR3 unbuffered ECC DIMMs (UDIMMs). DIMMs can be 1066 or 1333 MHz.

The system contains four memory sockets. Each two-socket set is organized into two channels. The first socket of each channel is marked with white release levers.

General Memory Module Installation Guidelines

To ensure optimal performance of your system, observe the following general guidelines when configuring your system memory.

 **NOTE:** Memory configurations that fail to observe these guidelines can prevent your system from starting and producing any video output.

- Except for memory channels that are unused, all populated memory channels must have identical configurations.
- Memory modules of different sizes can be mixed in sockets 1 to 4 (for example, 2 GB and 4 GB), but all populated channels must have identical configurations.
- Memory modules are installed in the numeric order of the sockets beginning with 1 to 4.

- One or two DIMMs per channel can support up to 1333 MHz.
- If memory modules with different speeds are installed, they will operate at the speed of the slowest installed memory module(s).

Mode-Specific Guidelines

Your system supports both single channel and dual channel modes. A minimal single-channel configuration of one 1 GB memory module per processor is also supported in this mode.

Table 5-1 shows sample memory configurations that follow the appropriate memory guidelines stated in this section. The samples show identical memory-module configurations and their physical and available memory totals. The table does not show mixed or quad-rank memory-module configurations, nor does it address the memory speed considerations of any configuration.

Table 5-1. Sample UDIMM Memory Configuration

Memory Module Size	Memory Sockets				Physical Memory (GB)
	1	3	2	4	
1 GB	X				1
	X		X		2
	X	X	X	X	4
2 GB	X				2
	X		X		4
	X	X	X	X	8
4 GB	X				4
	X		X		8
	X	X	X	X	16
8 GB	X				8
	X		X		16
	X	X	X	X	32

Installing Memory Modules

 **WARNING:** The memory modules are hot to the touch for some time after the system has been powered down. Allow time for the memory modules to cool before handling them. Handle the memory modules by the card edges and avoid touching the components on the memory module.

 **CAUTION:** Many repairs may only be done by a certified service technician. You should only perform troubleshooting and simple repairs as authorized in your product documentation, or as directed by the online or telephone service and support team. Damage due to servicing that is not authorized by Dell is not covered by your warranty. Read and follow the safety instructions that came with the product.

 **CAUTION:** To ensure proper system cooling, memory-module blanks must be installed in any memory socket that is not occupied. Remove memory-module blanks only if you intend to install memory in those sockets.

- 1 Turn off the system, including any attached peripherals, and disconnect the system from the electrical outlet.
- 2 Open the system. See "Opening the System" on page 50.
- 3 Remove the cooling shroud. See "Removing the Cooling Shroud" on page 67.
- 4 Locate the memory module sockets. See Figure 8-1.
- 5 Press the ejectors on the memory module socket down and out, as shown in Figure 5-12, to allow the memory module to be inserted into the socket.
- 6 Handle each memory module only on either card edge, making sure not to touch the middle of the memory module.

Figure 5-12. Removing and Installing a Memory Module

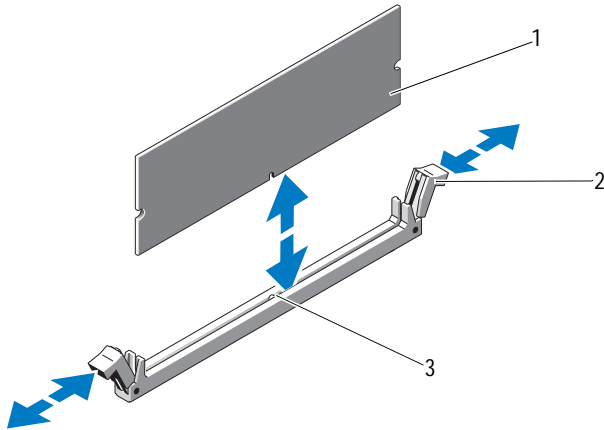

- 1 memory module
- 2 memory module socket ejectors (2)
- 3 alignment key

7 Align the memory module's edge connector with the alignment key of the memory module socket, and insert the memory module in the socket.

 **NOTE:** The memory module socket has an alignment key that allows you to install the memory module in the socket in only one way.

8 Press down on the memory module with your thumbs to lock the memory module into the socket.

When the memory module is properly seated in the socket, the ejectors on the memory module socket align with the ejectors on the other sockets that have memory modules installed.

9 Repeat step 5 through step 8 of this procedure to install the remaining memory modules. See Table 5-1.

10 Replace the cooling shroud. See "Installing the Cooling Shroud" on page 69.

11 Close the system. See "Closing the System" on page 51.

12 Start up the system, press < F2 > to enter the System Setup program, and check the **System Memory** setting on the main System Setup screen.

The system should have already changed the value to reflect the newly installed memory.

- 13 If the value is incorrect, one or more of the memory modules may not be installed properly. Repeat step 2 through step 12 of this procedure, checking to ensure that the memory modules are firmly seated in their sockets.
- 14 Run the system memory test in the system diagnostics. See "Running the Embedded System Diagnostics" on page 112.

Removing Memory Modules

 **WARNING:** The memory modules are hot to touch for some time after the system has been powered down. Allow time for the memory modules to cool before handling them. Handle the memory modules by the card edges and avoid touching the components on the memory module.

 **CAUTION:** Many repairs may only be done by a certified service technician. You should only perform troubleshooting and simple repairs as authorized in your product documentation, or as directed by the online or telephone service and support team. Damage due to servicing that is not authorized by Dell is not covered by your warranty. Read and follow the safety instructions that came with the product.

 **CAUTION:** To ensure proper system cooling, memory-module blanks must be installed in any memory socket that is not occupied. Remove memory-module blanks only if you intend to install memory in those sockets.

- 1 Turn off the system, including any attached peripherals, and disconnect the system from the electrical outlet.
- 2 Open the system. See "Opening the System" on page 50.
- 3 Remove the cooling shroud. See "Removing the Cooling Shroud" on page 67.
- 4 Locate the memory module sockets. See Figure 8-1.
- 5 Press down and out on the ejectors on each end of the socket until the memory module pops out of the socket. See Figure 5-12.
Handle each memory module only on either card edge, making sure not to touch the middle of the memory module.
- 6 Replace the cooling shroud. See "Installing the Cooling Shroud" on page 69.
- 7 Close the system. See "Closing the System" on page 51.
- 8 Reconnect the system and peripherals to their power sources, and turn them on.

Cooling Fans

Your system contains three single-motor fans and provides cooling for the processor, expansion card, and memory modules.



NOTE: Hot-swap removal or installation of the fans is not supported.



NOTE: In the event of a problem with a particular fan, the fan number is referenced by the system's management software, allowing you to easily identify and replace the proper fan by noting the fan numbers on the fan assembly.

Removing a Cooling Fan



WARNING: The cooling fan can continue to spin for some time after the system has been powered down. Allow time for the fan to stop spinning before removing it from the system.



WARNING: Do not attempt to operate the system without the cooling fan.



CAUTION: Many repairs may only be done by a certified service technician. You should only perform troubleshooting and simple repairs as authorized in your product documentation, or as directed by the online or telephone service and support team. Damage due to servicing that is not authorized by Dell is not covered by your warranty. Read and follow the safety instructions that came with the product.



NOTE: The procedure for removing each individual fan module is the same.

- 1 Turn off the system, including any attached peripherals, and disconnect the system from its electrical outlet.
- 2 Open the system. See "Opening the System" on page 50.
- 3 If applicable, remove the cooling shroud. See "Removing the Cooling Shroud" on page 67.
- 4 Disconnect the fan's power cable from the system board. See Figure 5-13.
- 5 Grasp the fan and lift it away from the fan assembly. See Figure 5-13.

Figure 5-13. Removing and Installing a Fan

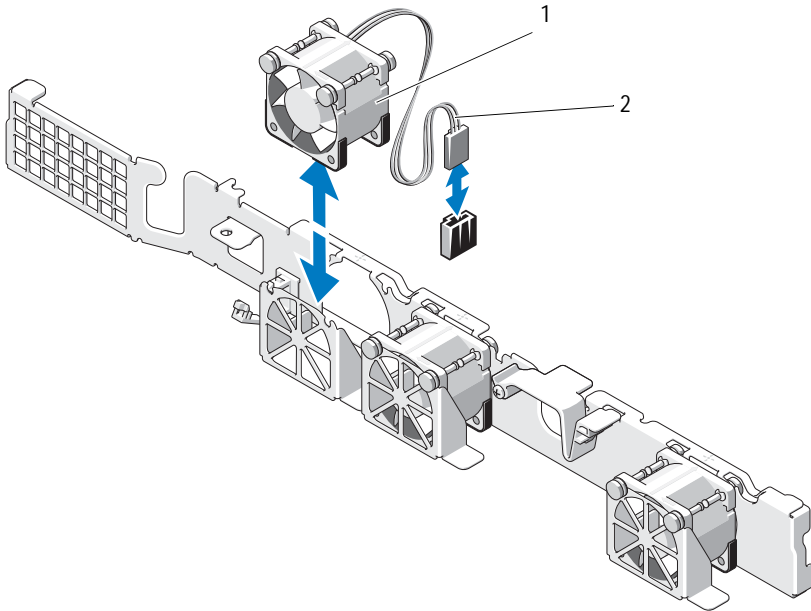

1 fan

2 power cable

Installing a Cooling Fan

CAUTION: Many repairs may only be done by a certified service technician. You should only perform troubleshooting and simple repairs as authorized in your product documentation, or as directed by the online or telephone service and support team. Damage due to servicing that is not authorized by Dell is not covered by your warranty. Read and follow the safety instructions that came with the product.

- 1 Ensure that the fan is oriented correctly.
Orient the fan module so that the side with the power cable faces the back of the system.
- 2 Lower the fan into the fan assembly until the fan is fully seated.
See Figure 5-13.
- 3 Connect the fan's power cable to the power connector on the system board.

- 4 If applicable, replace the cooling shroud. See "Installing the Cooling Shroud" on page 69.
- 5 Close the system. See "Closing the System" on page 51.
- 6 Reconnect the system to its electrical outlet and turn the system on, including any attached peripherals.

iDRAC6 Express Card (Optional)

Installing an iDRAC6 Express Card

 **CAUTION:** Many repairs may only be done by a certified service technician. You should only perform troubleshooting and simple repairs as authorized in your product documentation, or as directed by the online or telephone service and support team. Damage due to servicing that is not authorized by Dell is not covered by your warranty. Read and follow the safety instructions that came with the product.

- 1 Turn off the system, including any attached peripherals, and disconnect the system from the electrical outlet.
- 2 Open the system. See "Opening the System" on page 50.
- 3 If installed, remove the expansion card from the expansion-card slot. See "Removing an Expansion Card" on page 61.
- 4 Insert the tab on the Integrated Dell Remote Access Controller 6 (iDRAC6) Express card into the clip on the system board.
- 5 Align the front edge of the card with the connector on the system board. See Figure 8-1 for the location of the connector.
- 6 Press the card down until it is fully seated. See Figure 5-14.

When the front of the card is fully seated, the plastic standoff tab snaps over the edge of the holder.

Figure 5-14. Removing and Installing an iDRAC6 Express Card

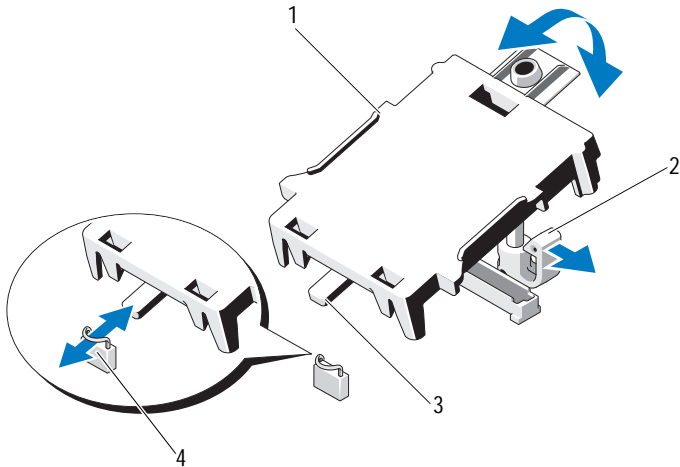

- | | | | |
|---|---------------------|---|----------------------|
| 1 | iDRAC6 Express card | 2 | plastic standoff tab |
| 3 | tab | 4 | clip |

- 7 If applicable, reinstall the expansion card. See "Installing an Expansion Card" on page 62.
- 8 Close the system. See "Closing the System" on page 51.
- 9 Reconnect the system to its electrical outlet and turn the system on, including any attached peripherals.

Removing an iDRAC6 Express Card



CAUTION: Many repairs may only be done by a certified service technician. You should only perform troubleshooting and simple repairs as authorized in your product documentation, or as directed by the online or telephone service and support team. Damage due to servicing that is not authorized by Dell is not covered by your warranty. Read and follow the safety instructions that came with the product.

- 1 Turn off the system, including any attached peripherals, and disconnect the system from the electrical outlet.
- 2 Open the system. See "Opening the System" on page 50.
- 3 If installed, remove the expansion card from the expansion slot. See "Removing an Expansion Card" on page 61.
- 4 Pull back slightly on the retention standoff tab at the front edge of the card and gently lift the card off the retention standoff. See Figure 5-15.

As the holder releases from the standoff, the connector under the card disengages from the system board connector.
- 5 Angle the card so that the tab on the card slips through the clip on the system board.
- 6 If applicable, reinstall the expansion card. See "Installing an Expansion Card" on page 62.
- 7 Close the system. See "Closing the System" on page 51.
- 8 Reconnect the system to its electrical outlet and turn the system on, including any attached peripherals.

iDRAC6 Enterprise Card (Optional)

Installing an iDRAC6 Enterprise Card

 **CAUTION:** Many repairs may only be done by a certified service technician. You should only perform troubleshooting and simple repairs as authorized in your product documentation, or as directed by the online or telephone service and support team. Damage due to servicing that is not authorized by Dell is not covered by your warranty. Read and follow the safety instructions that came with the product.

- 1 Turn off the system, including any attached peripherals, and disconnect the system from the electrical outlet.
- 2 Open the system. See "Opening the System" on page 50.
- 3 If installed, remove the expansion card from the expansion slot. See "Removing an Expansion Card" on page 61.
- 4 Remove the plastic filler plug for the iDRAC6 Enterprise port from the system back panel.
- 5 Angle the card so that the RJ-45 connector fits through the back-panel opening. See Figure 5-15.
- 6 Align the front edge of the card with the two front plastic retention standoffs next to the iDRAC6 connector on the system board, and lower the card into place. See Figure 5-15.

When the front of the card is fully seated, the plastic standoffs snap over the edge of the card.

Figure 5-15. Removing and Installing an iDRAC6 Enterprise Card

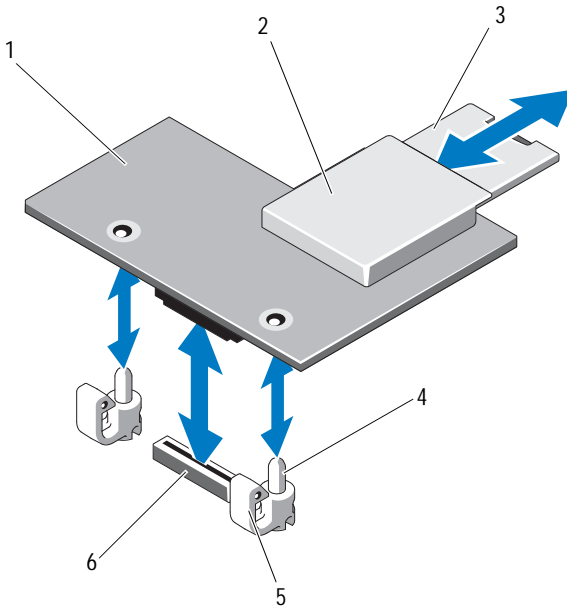

- | | | | |
|---|-----------------------------|---|----------------------------------|
| 1 | iDRAC6 Enterprise card | 2 | VFlash media slot |
| 3 | VFlash SD card | 4 | retention standoff posts (2) |
| 5 | retention standoff tabs (2) | 6 | iDRAC6 Enterprise card connector |

- 7 If applicable, reinstall the expansion card. See "Installing an Expansion Card" on page 62.
- 8 Close the system. See "Closing the System" on page 51.
- 9 Reconnect the system to its electrical outlet and turn the system on, including any attached peripherals.

Removing an iDRAC6 Enterprise Card



CAUTION: Many repairs may only be done by a certified service technician. You should only perform troubleshooting and simple repairs as authorized in your product documentation, or as directed by the online or telephone service and support team. Damage due to servicing that is not authorized by Dell is not covered by your warranty. Read and follow the safety instructions that came with the product.

- 1 Turn off the system, including any attached peripherals, and disconnect the system from the electrical outlet.
- 2 If present, disconnect the Ethernet cable from the iDRAC6 enterprise card connector on the system back panel. See Figure 3-2.
- 3 Open the system. See "Opening the System" on page 50.
- 4 If installed, remove the expansion card from the expansion-card slot. See "Removing an Expansion Card" on page 61.
- 5 Remove the VFlash media (if installed) from the iDRAC6 enterprise card. See "Removing a VFlash Media Card" on page 82.
- 6 Pull back slightly on the two tabs at the front edge of the card and gently lift the front edge of the card off of the retention standoffs.
As the card releases from the standoffs, the connector under the card disengages from the system board connector.
- 7 Slide the card away from the back of the system until the RJ-45 connector is clear of the back panel, then lift the card out of the system.
- 8 If applicable, reinstall the expansion card. See "Installing an Expansion Card" on page 62.
- 9 Replace the plastic filler plug over the port at the system back panel. See "Back-Panel Features and Indicators" on page 14 for the port location.
- 10 Close the system. See "Closing the System" on page 51.
- 11 Reconnect the system to its electrical outlet and turn the system on, including any attached peripherals.

VFlash Media (Optional)

The VFlash media card is a Secure Digital (SD) card that plugs into the optional iDRAC6 Enterprise card at the back corner of the system.

Installing a VFlash Media Card

- 1 Locate the VFlash media slot at the back corner of the system.
- 2 With the label side facing up, insert the contact-pin end of the SD card into the card slot on the module.



NOTE: The slot is keyed to ensure correct insertion of the card.

- 3 Press inward on the card to lock it into the slot.

Removing a VFlash Media Card

To remove the VFlash media, push inward on the card to release it, and pull the card from the card slot.

Processor

Removing a Processor



CAUTION: Many repairs may only be done by a certified service technician. You should only perform troubleshooting and simple repairs as authorized in your product documentation, or as directed by the online or telephone service and support team. Damage due to servicing that is not authorized by Dell is not covered by your warranty. Read and follow the safety instructions that came with the product.

- 1 Prior to upgrading your system, download the latest system BIOS version on support.dell.com.
- 2 Turn off the system, including any attached peripherals, and disconnect the system from the electrical outlet.
- 3 Open the system. See "Opening the System" on page 50.
- 4 Remove the cooling shroud. See "Removing the Cooling Shroud" on page 67.

 **WARNING:** The heat sink and processor are hot to touch for some time after the system has been powered down. Allow the heat sink and processor to cool before handling them.

 **CAUTION:** Never remove the heat sink from a processor unless you intend to remove the processor. The heat sink is necessary to maintain proper thermal conditions.

5 Using a #2 Phillips screwdriver, loosen one of the heat-sink retention screws. See Figure 5-16.

6 Wait 30 seconds for the heat sink to loosen from the processor.

7 Loosen the other heat-sink retention screws.

8 Gently lift the heat sink off of the processor and set the heat sink aside with thermal grease side facing up.

 **CAUTION:** The processor is held in its socket under strong pressure. Be aware that the release lever can spring up suddenly if not firmly grasped.

9 Position your thumb firmly over the processor socket-release lever and release the lever from the locked position.

10 Rotate the lever 90 degrees upward until the processor is released from the socket. See Figure 5-17.

Figure 5-16. Removing and Installing the Heat Sink

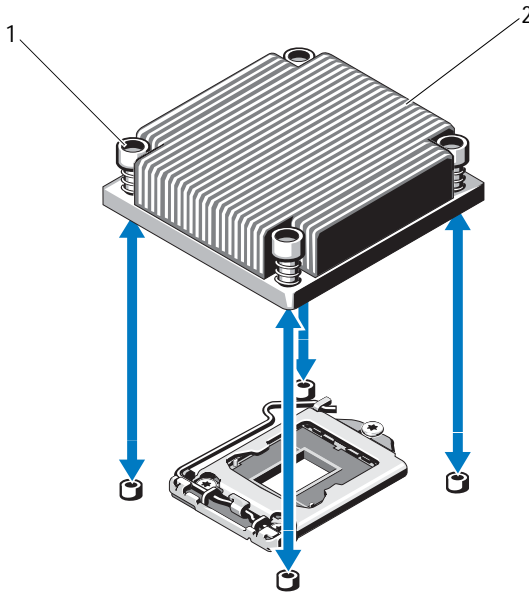

- 1 heat-sink retention screws (4) 2 heat sink

- 11 Rotate the processor shield upward and out of the way. See Figure 5-17.
- 12 Lift the processor out of the socket and leave the release lever up so that the socket is ready for the new processor.

CAUTION: Be careful not to bend any of the pins on the ZIF socket when removing the processor. Bending the pins can permanently damage the system board.

Figure 5-17. Removing and Installing a Processor

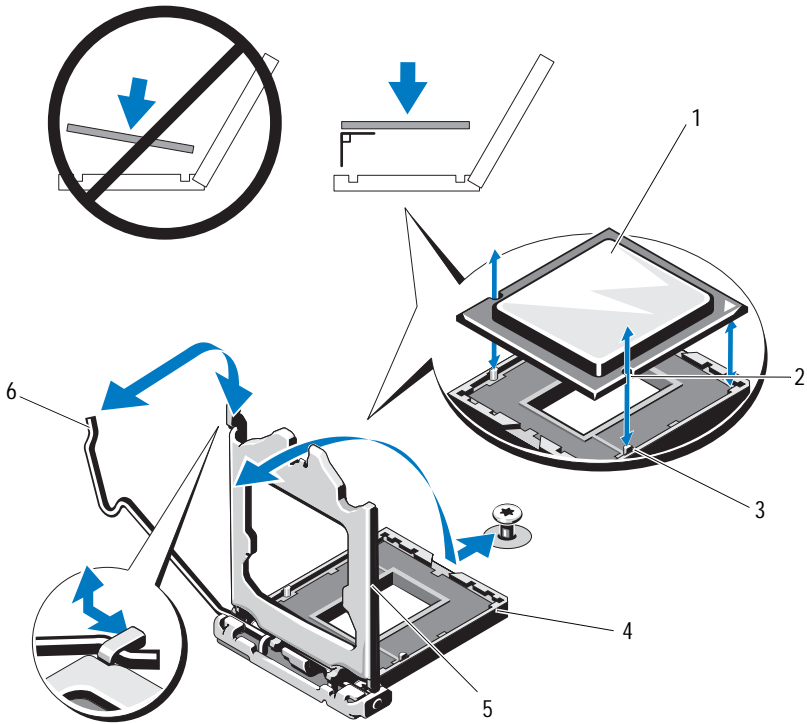

- | | | | |
|---|------------------|---|----------------------|
| 1 | processor | 2 | notch in processor |
| 3 | socket key | 4 | ZIF socket |
| 5 | processor shield | 6 | socket-release lever |

Installing a Processor

 **CAUTION:** Many repairs may only be done by a certified service technician. You should only perform troubleshooting and simple repairs as authorized in your product documentation, or as directed by the online or telephone service and support team. Damage due to servicing that is not authorized by Dell is not covered by your warranty. Read and follow the safety instructions that came with the product.

- 1 If you are upgrading your processor, prior to upgrading your system, download and install the latest system BIOS version from **support.dell.com**. Follow the instructions included in the file download to install the update on your system.
- 2 Unpack the processor if it has not been used previously.
If the processor has already been used, remove any thermal grease from the top of the processor using a lint-free cloth.
- 3 Align the processor with the socket keys on the ZIF socket. See Figure 5-17.

 **CAUTION:** Positioning the processor incorrectly can permanently damage the system board or the processor. Be careful not to bend the pins in the socket.

- 4 With the release lever on the processor socket in the open position, align the processor with the socket keys and set the processor lightly in the socket.

 **CAUTION:** Do not use force to seat the processor. When the processor is positioned correctly, it engages easily into the socket.

- 5 Close the processor shield.
- 6 Rotate the socket release lever down until it snaps into place.
- 7 Using a clean lint-free cloth, remove the thermal grease from the heat sink.
- 8 Open the grease packet included with your processor kit and apply thermal grease evenly to the center of the top of the new processor.

 **CAUTION:** Using excess thermal grease can cause grease to contact the processor shield, which can cause contamination of the processor socket.

- 9 Place the heat sink on the processor. See Figure 5-16.
- 10 Using a #2 Phillips screwdriver, tighten the heat-sink retention screws. See Figure 5-16.

- 11 Replace the cooling shroud. See "Installing the Cooling Shroud" on page 69.
- 12 Close the system. See "Closing the System" on page 51.
- 13 Reconnect the system to its electrical outlet and turn the system on, including any attached peripherals.
- 14 Press < F2 > to enter the System Setup program, and check that the processor information matches the new system configuration. See "Entering the System Setup Program" on page 26.
- 15 Run the system diagnostics to verify that the new processor operates correctly.
See "Running the Embedded System Diagnostics" on page 112 for information about running the diagnostics.

Power Supply

Your system supports a 250 W power supply module.

Removing the Power Supply

 **CAUTION:** Many repairs may only be done by a certified service technician. You should only perform troubleshooting and simple repairs as authorized in your product documentation, or as directed by the online or telephone service and support team. Damage due to servicing that is not authorized by Dell is not covered by your warranty. Read and follow the safety instructions that came with the product.

- 1 Turn off the system and all attached peripherals.
- 2 Disconnect the power cable from the power source.



NOTE: You may have to unlatch and lift the optional cable management arm if it interferes with power-supply removal. For information about the cable management arm, see the system's rack documentation.

- 3 Open the system. See "Opening the System" on page 50.
- 4 Disconnect all the power cables from the power supply to the system board, hard drive(s), and optical drive. See Figure 5-18.

Note the routing of the power cables as you remove them from the system board and drives. You must route these cables properly when you replace them to prevent them from being pinched or crimped.

- 5 Remove the screw securing the power supply to the chassis.
- 6 Slide and lift the power supply to remove it from the chassis. See Figure 5-18.

Figure 5-18. Removing and Installing the Power Supply

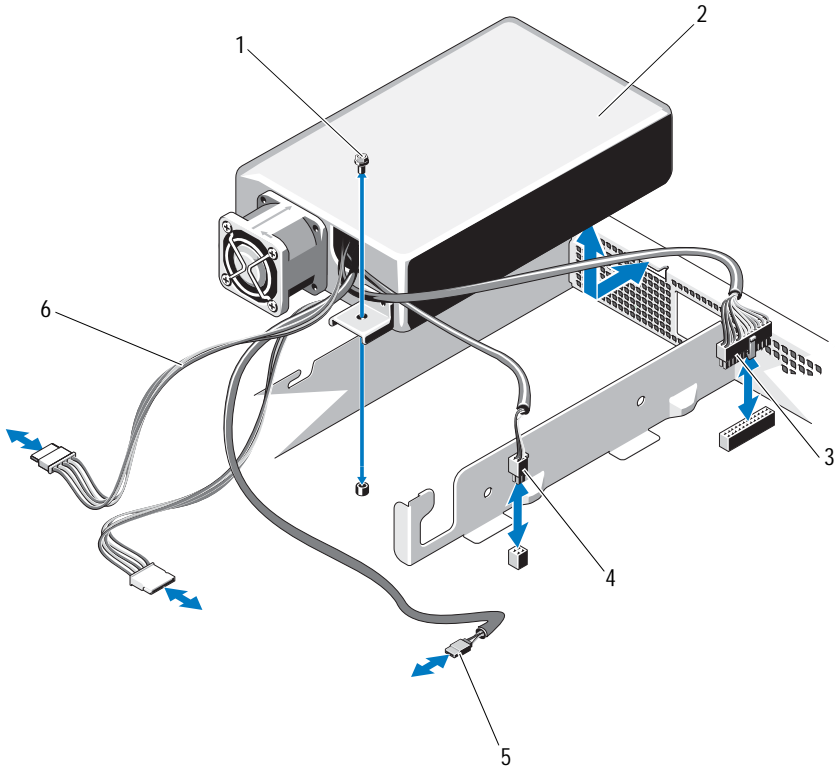

- | | | | |
|---|---------------------|---|-----------------------|
| 1 | screw | 2 | power supply |
| 3 | 24-pin power cable | 4 | 4-pin power cable |
| 5 | optical drive cable | 6 | SATA power cables (2) |

Installing the Power Supply

 **CAUTION:** Many repairs may only be done by a certified service technician. You should only perform troubleshooting and simple repairs as authorized in your product documentation, or as directed by the online or telephone service and support team. Damage due to servicing that is not authorized by Dell is not covered by your warranty. Read and follow the safety instructions that came with the product.

- 1 Open the system. See "Opening the System" on page 50.
- 2 Angle the power supply so that the connector fits through the back-panel opening.
- 3 Align the screw hole on the power supply with the hole on the chassis. See Figure 5-18.
- 4 Tighten the screw to secure the power supply to the chassis.
- 5 Connect all the power cables to the system board, hard drive(s), and optical drive.
You must route these cables properly to prevent them from being pinched or crimped.
- 6 Close the system. See "Closing the System" on page 51.
- 7 Reconnect the system to its electrical outlet and turn the system on, including any attached peripherals.

System Battery

Replacing the System Battery

 **WARNING:** There is a danger of a new battery exploding if it is incorrectly installed. Replace the battery only with the same or equivalent type recommended by the manufacturer. See your safety information for additional information.

 **CAUTION:** Many repairs may only be done by a certified service technician. You should only perform troubleshooting and simple repairs as authorized in your product documentation, or as directed by the online or telephone service and support team. Damage due to servicing that is not authorized by Dell is not covered by your warranty. Read and follow the safety instructions that came with the product.

- 1 Turn off the system, including any attached peripherals, and disconnect the system from the electrical outlet.
- 2 Open the system. See "Opening the System" on page 50.

Figure 5-19. Replacing the System Battery

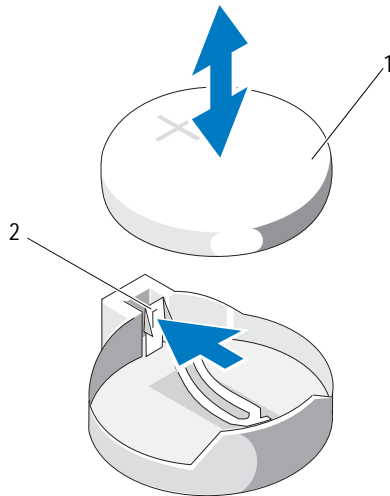

1 system battery

2 metal tab

- 3 Locate the battery socket. See Figure 8-1.

CAUTION: To avoid damage to the battery connector, you must firmly support the connector while installing or removing a battery.

- 4 To remove the battery, push the metal tab away from the battery until the battery pops out. See Figure 5-19.
- 5 To install the new system battery, hold the battery with the "+" facing up, and aligned to the metal tab on the socket.
- 6 Press the battery straight down into the socket until it snaps into place.
- 7 Close the system. See "Closing the System" on page 51.
- 8 Reconnect the system to its electrical outlet and turn the system on, including any attached peripherals.

- 9 Enter the System Setup program to confirm that the battery is operating properly. See "Entering the System Setup Program" on page 26.
- 10 Enter the correct time and date in the System Setup program's **Time** and **Date** fields.
- 11 Exit the System Setup program.

Control Panel Assembly

Removing the Control Panel Assembly

 **CAUTION:** Many repairs may only be done by a certified service technician. You should only perform troubleshooting and simple repairs as authorized in your product documentation, or as directed by the online or telephone service and support team. Damage due to servicing that is not authorized by Dell is not covered by your warranty. Read and follow the safety instructions that came with the product.

- 1 If installed, remove the front bezel. See "Removing the Front Bezel" on page 49.
- 2 Turn off the system and attached peripherals, and disconnect the system from the electrical outlet and peripherals.
- 3 Open the system. See "Opening the System" on page 50.
- 4 Remove hard drive 0. See "Removing a 3.5-Inch Hard Drive" on page 56.
- 5 Remove the internal USB key (if present). See "Internal USB Memory Key" on page 65.
- 6 Disconnect the control panel cable at back of the control panel board:

 **CAUTION:** Do not pull on the cable to unseat the connector. Doing so can damage the cable.

- a Press the metal tabs on the ends of the cable connector.
 - b Gently work the connector out of the socket.
 - c Remove the USB connector cable from the control panel.
- 7 Remove the four screws that secure the control panel board to the chassis and remove the board.

Figure 5-20. Removing and Installing the Control Panel

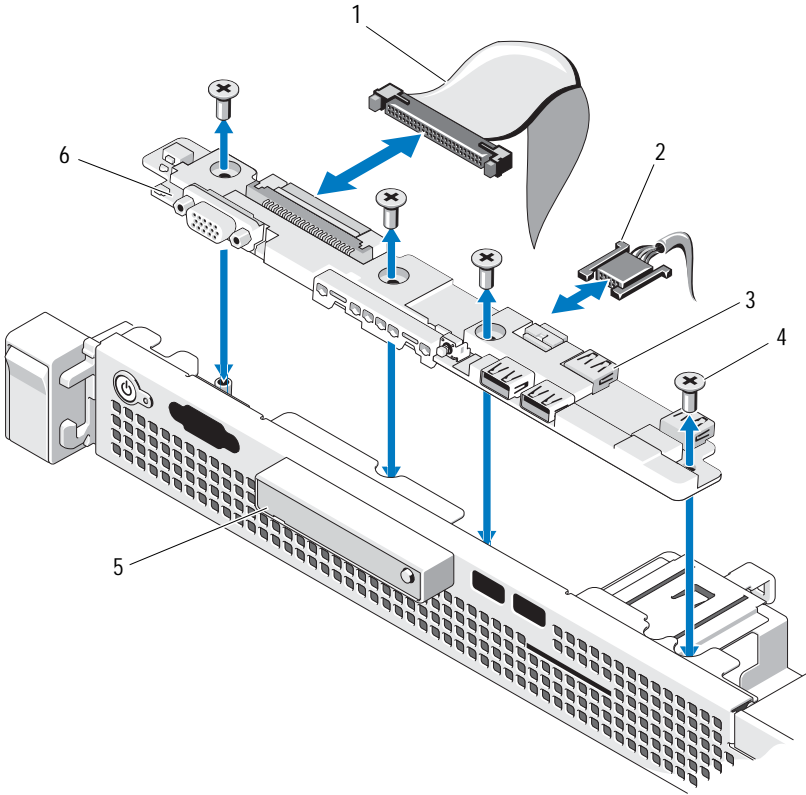

- 1 control panel cable
- 3 USB connectors (4)
- 5 LED display module

- 2 USB connector cable
- 4 screws (4)
- 6 control panel board

Installing the Control Panel Assembly

 **CAUTION:** Many repairs may only be done by a certified service technician. You should only perform troubleshooting and simple repairs as authorized in your product documentation, or as directed by the online or telephone service and support team. Damage due to servicing that is not authorized by Dell is not covered by your warranty. Read and follow the safety instructions that came with the product.

- 1 Align the screw holes on the control panel board with the holes on the chassis.
- 2 Replace the screws on the control panel assembly. See Figure 5-20.
- 3 Connect the control panel cable to the control panel board.
- 4 Connect the USB connector cable.
- 5 Replace the hard drive. See "Installing a 3.5-Inch Hard Drive" on page 58.
- 6 If present, replace the internal USB key. See "Internal USB Memory Key" on page 65.
- 7 Close the system. See "Closing the System" on page 51.
- 8 If applicable, replace the front bezel. See "Installing the Front Bezel" on page 49.
- 9 Reconnect the system to the power source and turn on the system and attached peripherals.

System Board

Removing the System Board

 **CAUTION:** Many repairs may only be done by a certified service technician. You should only perform troubleshooting and simple repairs as authorized in your product documentation, or as directed by the online or telephone service and support team. Damage due to servicing that is not authorized by Dell is not covered by your warranty. Read and follow the safety instructions that came with the product.

 **CAUTION:** If you are using the Trusted Program Module (TPM) with an encryption key, you may be prompted to create a recovery key during program or system setup. Be sure to create and safely store this recovery key. If you replace this system board, you must supply the recovery key when you restart your system or program before you can access the encrypted data on your hard drives.

- 1 Turn off the system and attached peripherals, and disconnect the system from the electrical outlet.
- 2 Open the system. See "Opening the System" on page 50.
- 3 Remove the cooling shroud. See "Removing the Cooling Shroud" on page 67.
- 4 Remove any expansion card. See "Removing an Expansion Card" on page 61.
- 5 Remove the processor heat sink. See "Removing a Processor" on page 82.
- 6 If installed, remove the iDRAC6 Enterprise card. See "Removing an iDRAC6 Enterprise Card" on page 81.
- 7 If installed, remove the iDRAC6 Express card. See "Removing an iDRAC6 Express Card" on page 78.
- 8 Disconnect all cables from the system board.
- 9 Remove all the memory modules and memory blanks. See "Removing Memory Modules" on page 73.



NOTE: To ensure proper reinstallation of memory modules, record the memory module socket locations.

- 10 Remove the ten screws securing the system board to the chassis and then slide the system board assembly toward the front end of the chassis.



CAUTION: Do not lift the system board assembly by grasping a memory module, processor, or other components.

- 11 Grasp the system board assembly by its edges and lift the assembly away from the chassis. See Figure 5-21.

Figure 5-21. Removing and Installing the System Board

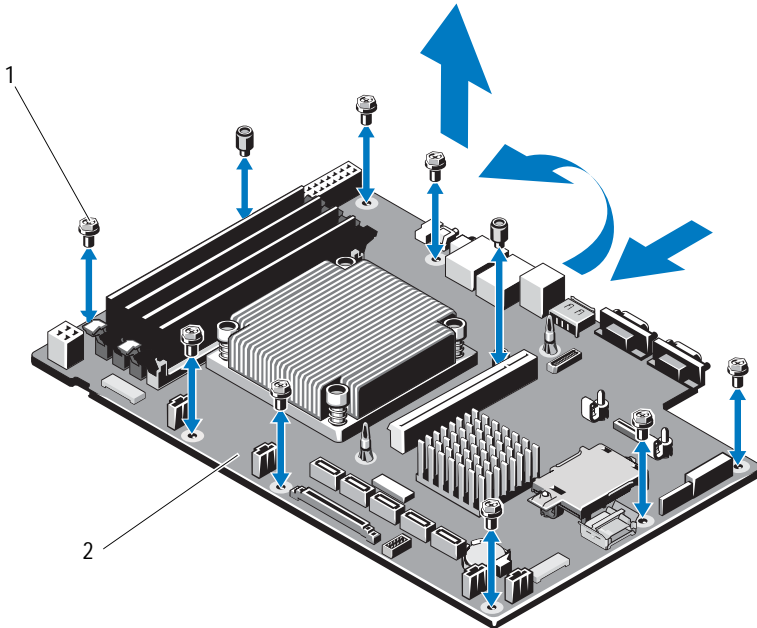

1 screws (10)

2 system board assembly

Installing the System Board

⚠ CAUTION: Many repairs may only be done by a certified service technician. You should only perform troubleshooting and simple repairs as authorized in your product documentation, or as directed by the online or telephone service and support team. Damage due to servicing that is not authorized by Dell is not covered by your warranty. Read and follow the safety instructions that came with the product.

- 1 Unpack the new system board.
- 2 Remove the labels from the processor shield and affix them to the system identification panel on the front of the system. See Figure 3-1.
- 3 Holding the system board by its edges, lower it into the chassis.

 **CAUTION:** Do not lift the system board assembly by grasping a memory module, processor, or other components.

- 4 Slightly lift up the front of the system board and maneuver the system board to the bottom of the chassis until it lays completely flat.
- 5 Push the system board toward the back of the chassis until the board is in place.
- 6 Tighten the ten screws that secure the system board to the chassis. See Figure 5-21.
- 7 Transfer the processor and the heat sink to the new system board. See "Removing a Processor" on page 82 and "Installing a Processor" on page 86.
- 8 Replace all the memory modules and memory blanks. See "Installing Memory Modules" on page 71.
- 9 Connect the cables in the order listed below (see Figure 8-1 for the locations of the connectors on the system board):
 - SATA interface cable, if applicable
 - Control panel interface cable
 - Optical drive power cable
 - Control panel USB interface cable
 - System board power cables
- 10 Install the expansion card, if any. See "Installing an Expansion Card" on page 62.
- 11 If applicable, reinstall the iDRAC6 Enterprise card. See "Installing an iDRAC6 Enterprise Card" on page 79.
- 12 If applicable, reinstall the iDRAC6 Express card. See "Installing an iDRAC6 Express Card" on page 76.
- 13 Replace the cooling shroud. See "Installing the Cooling Shroud" on page 69.
- 14 Close the system. See "Closing the System" on page 51.
- 15 Reconnect the system to its electrical outlet and turn the system on, including any attached peripherals.

Troubleshooting Your System

Safety First—For You and Your System

△ CAUTION: Many repairs may only be done by a certified service technician. You should only perform troubleshooting and simple repairs as authorized in your product documentation, or as directed by the online or telephone service and support team. Damage due to servicing that is not authorized by Dell is not covered by your warranty. Read and follow the safety instructions that came with the product.

Troubleshooting System Startup Failure

If your system halts during startup prior to video output, especially after installing an operating system or your system's hardware, check for the following conditions:

- If you boot the system to the BIOS boot mode after installing an operating system from the Boot Manager, the system will hang. The reverse is also true. You must boot to the same boot mode in which you installed the operating system. See "Using the System Setup Program and Boot Manager" on page 25.
- Invalid memory configurations could cause the system to halt at startup without any video output. See "System Memory" on page 69.

For all other startup issues, note the system messages that appear onscreen. See "System Messages" on page 19 for more information.

Troubleshooting External Connections

Ensure that all external cables are securely attached to the external connectors on your system before troubleshooting any external devices. See Figure 3-1 and Figure 3-2 for the front-panel and back-panel connectors on your system.

Troubleshooting the Video Subsystem

- 1 Check the system and power connections to the monitor.
- 2 Check the video interface cabling from the system to the monitor.
- 3 Run the appropriate online diagnostic test. See "Running the System Diagnostics" on page 111.

If the tests run successfully, the problem is not related to video hardware.

If the tests fail, see "Getting Help" on page 119.

Troubleshooting a USB Device

Use the following steps to troubleshoot a USB keyboard /mouse. For other USB devices, go to step 4.

- 1 Disconnect the keyboard and mouse cables from the system briefly and reconnect them.
- 2 Connect the keyboard/mouse to the USB port(s) on the opposite side of the system.
- 3 If the problem is resolved, restart the system, enter the System Setup program, and check if the non functioning USB ports are enabled.
- 4 Replace the keyboard/mouse with another working keyboard/mouse.
- 5 If the problem is resolved, replace the faulty keyboard/mouse.
- 6 If the problem is not resolved, proceed to the next step to begin troubleshooting the other USB devices attached to the system.
- 7 Power down all attached USB devices and disconnect them from the system.
- 8 Restart the system and, if your keyboard is functioning, enter the system setup program. Verify that all USB ports are enabled. See "Integrated Devices Screen" on page 31.

If your keyboard is not functioning, you can also use remote access. If the system is not accessible, see "Disabling a Forgotten Password" on page 118 for instructions on setting the NVRAM_CLR jumper inside your system and restoring the BIOS to the default settings.

- 9 Reconnect and power on each USB device one at a time.
- 10 If a device causes the same problem, power down the device, replace the USB cable, and power up the device.
If the problem persists, replace the device.
If all troubleshooting fails, see "Getting Help" on page 119.

Troubleshooting a Serial I/O Device

- 1 Turn off the system and any peripheral devices connected to the serial port.
- 2 Swap the serial interface cable with another working cable, and turn on the system and the serial device.
If the problem is resolved, replace the interface cable.
- 3 Turn off the system and the serial device, and swap the device with a comparable device.
- 4 Turn on the system and the serial device.
If the problem is resolved, replace the serial device.
If the problem persists, see "Getting Help" on page 119.

Troubleshooting a NIC

- 1 Run the appropriate online diagnostic test. See "Running the System Diagnostics" on page 111.
- 2 Restart the system and check for any system messages pertaining to the NIC controller.
- 3 Check the appropriate indicator on the NIC connector. See "NIC Indicator Codes" on page 16.
 - If the link indicator does not light, check all cable connections.
 - If the activity indicator does not light, the network driver files might be damaged or missing.
Remove and reinstall the drivers if applicable. See the NIC's documentation.

- Change the autonegotiation setting, if possible.
- Use another connector on the switch or hub.

If you are using a NIC card instead of an integrated NIC, see the documentation for the NIC card.

- 4 Ensure that the appropriate drivers are installed and the protocols are bound. See the NIC's documentation.
- 5 Enter the System Setup program and confirm that the NIC ports are enabled. See "Integrated Devices Screen" on page 31.
- 6 Ensure that the NICs, hubs, and switches on the network are all set to the same data transmission speed. See the documentation for each network device.
- 7 Ensure that all network cables are of the proper type and do not exceed the maximum length.

If all troubleshooting fails, see "Getting Help" on page 119.

Troubleshooting a Wet System

 **CAUTION:** Many repairs may only be done by a certified service technician. You should only perform troubleshooting and simple repairs as authorized in your product documentation, or as directed by the online or telephone service and support team. Damage due to servicing that is not authorized by Dell is not covered by your warranty. Read and follow the safety instructions that came with the product.

- 1 Turn off the system and attached peripherals, and disconnect the system from the electrical outlet.
- 2 Open the system. See "Opening the System" on page 50.
- 3 Remove the following components from the system. See "Installing System Components" on page 47.
 - Hard drives
 - USB memory key
 - NIC hardware key
 - VFlash media
 - Expansion card and expansion-card riser

- iDRAC6 Enterprise card
 - iDRAC6 Express card
 - Power supply
 - Fans
 - Processor and heat sink
 - Memory modules
- 4 Let the system dry thoroughly for at least 24 hours.
 - 5 Reinstall the components you removed in step 3.
 - 6 Close the system. See "Closing the System" on page 51.
If the system does not start properly, see "Getting Help" on page 119.
 - 7 If the system starts properly, shut down the system and reinstall the expansion card that you removed. See "Installing an Expansion Card" on page 62.
 - 8 Run the appropriate online diagnostic test. See "Running the System Diagnostics" on page 111.
If the tests fail, see "Getting Help" on page 119.

Troubleshooting a Damaged System

 **CAUTION:** Many repairs may only be done by a certified service technician. You should only perform troubleshooting and simple repairs as authorized in your product documentation, or as directed by the online or telephone service and support team. Damage due to servicing that is not authorized by Dell is not covered by your warranty. Read and follow the safety instructions that came with the product.

- 1 Open the system. See "Opening the System" on page 50.
- 2 Ensure that the following components are properly installed:
 - Expansion card and expansion-card riser
 - Power supply
 - Fans
 - Processor and heat sink
 - Memory modules

- Hard-drive carriers
 - Cooling shroud
- 3 Ensure that all cables are properly connected.
 - 4 Close the system. See "Closing the System" on page 51.
 - 5 Run the system board tests in the system diagnostics. See "Running the System Diagnostics" on page 111.
- If the tests fail, see "Getting Help" on page 119.

Troubleshooting the System Battery



NOTE: If the system is turned off for long periods of time (for weeks or months), the NVRAM may lose its system configuration information. This situation is caused by a defective battery.

- 1 Re-enter the time and date through the System Setup program. See "Using the System Setup Program and Boot Manager" on page 25.
- 2 Turn off the system and disconnect it from the electrical outlet for at least one hour.
- 3 Reconnect the system to the electrical outlet and turn on the system.
- 4 Enter the System Setup program.

If the date and time are not correct in the System Setup program, replace the battery. See "Replacing the System Battery" on page 89.

If the problem is not resolved by replacing the battery, see "Getting Help" on page 119.



NOTE: Some software may cause the system time to speed up or slow down. If the system seems to operate normally except for the time kept in the System Setup program, the problem may be caused by software rather than by a defective battery.

Troubleshooting Power Supply

- 1 Reseat the power supply by removing and reinstalling it. See "Removing the Power Supply" on page 87 and "Installing the Power Supply" on page 89.

 **NOTE:** After installing a power supply, allow several seconds for the system to recognize the power supply and to determine if it is working properly.

- 2 If the problem persists, replace the faulty power supply.
If the problem is not resolved by replacing the power supply, see "Getting Help" on page 119.

Troubleshooting System Cooling Problems

 **CAUTION:** Many repairs may only be done by a certified service technician. You should only perform troubleshooting and simple repairs as authorized in your product documentation, or as directed by the online or telephone service and support team. Damage due to servicing that is not authorized by Dell is not covered by your warranty. Read and follow the safety instructions that came with the product.

Ensure that none of the following conditions exist:

- System cover, cooling shroud, drive blank, memory-module blank, power-supply blank, or back filler bracket is removed.
- Ambient temperature is too high.
- External airflow is obstructed.
- An individual cooling fan is removed or has failed. See "Troubleshooting a Fan" on page 103.

Troubleshooting a Fan

 **CAUTION:** Many repairs may only be done by a certified service technician. You should only perform troubleshooting and simple repairs as authorized in your product documentation, or as directed by the online or telephone service and support team. Damage due to servicing that is not authorized by Dell is not covered by your warranty. Read and follow the safety instructions that came with the product.

- 1 Locate the faulty fan indicated by the diagnostic software.

- 2 Turn off the system and all attached peripherals.
- 3 Open the system. See "Opening the System" on page 50.
- 4 Reseat the fan's power cable.
- 5 Restart the system.
If the fan functions properly, close the system. See "Closing the System" on page 51.
- 6 If the fan does not function, turn off the system and install a new fan. See "Cooling Fans" on page 74.
- 7 Restart the system.
If the problem is resolved, close the system. See "Closing the System" on page 51.
If the replacement fan does not operate, see "Getting Help" on page 119.

Troubleshooting System Memory

 **CAUTION:** Many repairs may only be done by a certified service technician. You should only perform troubleshooting and simple repairs as authorized in your product documentation, or as directed by the online or telephone service and support team. Damage due to servicing that is not authorized by Dell is not covered by your warranty. Read and follow the safety instructions that came with the product.

 **NOTE:** Invalid memory configurations can cause your system to halt at startup without video output. See General Memory Module Installation Guidelines and verify that your memory configuration complies with all applicable guidelines.

- 1 If the system is operational, run the appropriate online diagnostic test. See "Running the System Diagnostics" on page 111.
If diagnostics indicates a fault, follow the corrective actions provided by the diagnostic program.
- 2 If the system is not operational, turn off the system and attached peripherals, and unplug the system from the power source. Wait at least 10 seconds and then reconnect the system to power.
- 3 Turn on the system and attached peripherals and note the messages on the screen.

Go to step 12 if an error message appears indicating a fault with a specific memory module.

- 4 Enter the System Setup program and check the system memory setting. See "Memory Settings Screen" on page 29. Make any changes to the memory settings, if needed.

If the memory settings match the installed memory but a problem is still indicated, go to step 12.

- 5 Turn off the system and attached peripherals, and disconnect the system from the electrical outlet.
- 6 Open the system. See "Opening the System" on page 50.
- 7 Check the memory banks and ensure that they are populated correctly. See "General Memory Module Installation Guidelines" on page 69.
- 8 Reseat the memory modules in their sockets. See "Installing Memory Modules" on page 71.
- 9 Close the system. See "Closing the System" on page 51.
- 10 Reconnect the system to its electrical outlet, and turn on the system and attached peripherals.
- 11 Enter the System Setup program and check the system memory setting. See "Memory Settings Screen" on page 29.
If the problem is not resolved, proceed with the next step.
- 12 Turn off the system and attached peripherals, and disconnect the system from the power source.
- 13 Open the system. See "Opening the System" on page 50.
- 14 If a diagnostic test or error message indicates a specific memory module as faulty, swap or replace the module.
- 15 To troubleshoot an unspecified faulty memory module, replace the memory module in the first DIMM socket with a module of the same type and capacity. See "Installing Memory Modules" on page 71.
- 16 Close the system. See "Closing the System" on page 51.
- 17 As the system boots, observe any error message that appears and the diagnostic indicators on the front of the system.

- 18 If the memory problem is still indicated, repeat step 12 through step 17 for each memory module installed.

If the problem persists after all memory modules have been checked, see "Getting Help" on page 119.

Troubleshooting an Internal USB Key

 **CAUTION:** Many repairs may only be done by a certified service technician. You should only perform troubleshooting and simple repairs as authorized in your product documentation, or as directed by the online or telephone service and support team. Damage due to servicing that is not authorized by Dell is not covered by your warranty. Read and follow the safety instructions that came with the product.

- 1 Enter the System Setup program and ensure that the USB key port is enabled. See "Integrated Devices Screen" on page 31.
- 2 Turn off the system and attached peripherals.
- 3 Open the system. See "Opening the System" on page 50.
- 4 Locate the USB key and reseal it. See "Internal USB Memory Key" on page 65.
- 5 Close the system. See "Closing the System" on page 51.
- 6 Turn on the system and attached peripherals and check if the USB key is functioning.
- 7 If the problem is not resolved, repeat step 2 and step 3.
- 8 Insert a different USB key that you know works properly.
- 9 Close the system. See "Closing the System" on page 51.
- 10 Turn on the system and attached peripherals and check if the USB key is functioning.

If the problem is not resolved, see "Getting Help" on page 119.

Troubleshooting an Optical Drive

 **CAUTION:** Many repairs may only be done by a certified service technician. You should only perform troubleshooting and simple repairs as authorized in your product documentation, or as directed by the online or telephone service and support team. Damage due to servicing that is not authorized by Dell is not covered by your warranty. Read and follow the safety instructions that came with the product.

- 1 Try using a different CD or DVD.
- 2 Enter the System Setup program and ensure that the drive's controller is enabled. See "Entering the System Setup Program" on page 26.
- 3 Run the appropriate online diagnostic test. See "Running the System Diagnostics" on page 111.
- 4 Turn off the system and attached peripherals, and disconnect the system from the electrical outlet.
- 5 Open the system. See "Opening the System" on page 50.
- 6 Ensure that the interface cable is securely connected to the optical drive and to the controller.
- 7 Ensure that a power cable is properly connected to the drive.
- 8 Close the system. See "Closing the System" on page 51.

If the problem is not resolved, see "Getting Help" on page 119.

Troubleshooting a Hard Drive

 **CAUTION:** Many repairs may only be done by a certified service technician. You should only perform troubleshooting and simple repairs as authorized in your product documentation, or as directed by the online or telephone service and support team. Damage due to servicing that is not authorized by Dell is not covered by your warranty. Read and follow the safety instructions that came with the product.

 **CAUTION:** This troubleshooting procedure can destroy data stored on the hard drive. Before you proceed, back up all files on the hard drive.

- 1 Run the appropriate online diagnostics test. See "Running the System Diagnostics" on page 111.

Depending on the results of the diagnostics test, proceed as needed through the following steps.

- 2 If your system has a RAID controller card and your hard drives are configured in a RAID array, perform the following steps:
 - a Restart the system and enter the host adapter configuration utility program by pressing < Ctrl> < R> for a PERC controller or < Ctrl> < C> for a SAS controller.
See the documentation supplied with the host adapter for information about the configuration utility.
 - b Ensure that the hard drive(s) have been configured correctly for the RAID array.
 - c Take the hard drive offline and reseal the drive. See "Removing a 3.5-Inch Hard Drive" on page 56.
 - d Exit the configuration utility and allow the system to boot to the operating system.
- 3 Ensure that the required device drivers for your controller card are installed and are configured correctly. See the operating system documentation for more information.
- 4 Restart the system, enter the System Setup program, and verify that the drives appear in the System Setup program. See "Entering the System Setup Program" on page 26.

Troubleshooting an Expansion Card

 **CAUTION:** Many repairs may only be done by a certified service technician. You should only perform troubleshooting and simple repairs as authorized in your product documentation, or as directed by the online or telephone service and support team. Damage due to servicing that is not authorized by Dell is not covered by your warranty. Read and follow the safety instructions that came with the product.

 **NOTE:** When troubleshooting an expansion card, see the documentation for your operating system and the expansion card.

- 1 Run the appropriate online diagnostic test. See "Running the System Diagnostics" on page 111.
- 2 Turn off the system and attached peripherals, and disconnect the system from the electrical outlet.
- 3 Open the system. See "Opening the System" on page 50.
- 4 Ensure that the expansion-card riser is firmly seated in its connector. See "Installing an Expansion Card" on page 62.
- 5 Ensure that the expansion card is firmly seated in its connector. See "Installing an Expansion Card" on page 62.
- 6 Close the system. See "Closing the System" on page 51.
- 7 If the problem is not resolved, turn off the system and attached peripherals, and disconnect the system from the electrical outlet.
- 8 Open the system. See "Opening the System" on page 50.
- 9 Remove the expansion card. See "Removing an Expansion Card" on page 61.
- 10 Close the system. See "Closing the System" on page 51.
- 11 Run the appropriate online diagnostic test.
If the tests fail, see "Getting Help" on page 119.

Troubleshooting the Processor

 **CAUTION:** Many repairs may only be done by a certified service technician. You should only perform troubleshooting and simple repairs as authorized in your product documentation, or as directed by the online or telephone service and support team. Damage due to servicing that is not authorized by Dell is not covered by your warranty. Read and follow the safety instructions that came with the product.

- 1 Run the appropriate online diagnostics test. See "Using Online Diagnostics" on page 111.
- 2 Turn off the system and attached peripherals, and disconnect the system from the electrical outlet.
- 3 Open the system. See "Opening the System" on page 50.
- 4 Ensure that the processor and heat sink are properly installed. See "Processor" on page 82.
- 5 Close the system. See "Closing the System" on page 51.
- 6 Run the appropriate online diagnostic test.
If a problem is still indicated, see "Getting Help" on page 119.

Running the System Diagnostics

If you experience a problem with your system, run the diagnostics before calling for technical assistance. The purpose of the diagnostics is to test your system's hardware without requiring additional equipment or risking data loss. If you are unable to fix the problem yourself, service and support personnel can use diagnostics test results to help you solve the problem.

Using Online Diagnostics

To assess a system problem, first use the online diagnostics. Online Diagnostics is a suite of diagnostic programs, or test modules, that include diagnostic tests on chassis and storage components such as hard drives, physical memory, communications and printer ports, NICs, CMOS, and more. If you are unable to identify the problem using the online diagnostics, then use the embedded system diagnostics.

The files required to run the online diagnostics for systems running supported Microsoft Windows and Linux operating systems are available at support.dell.com and on the media that came with your system. For information about using diagnostics, see the *Dell Online Diagnostics User's Guide*.

Embedded System Diagnostics Features

The system diagnostics provides a series of menus and options for particular device groups or devices. The system diagnostics menus and options allow you to:

- Run tests individually or collectively
- Control the sequence of tests
- Repeat tests
- Display, print, or save test results
- Temporarily suspend testing if an error is detected or terminate testing when a user-defined error limit is reached
- View help messages that briefly describe each test and its parameters

- View status messages that inform you if tests are completed successfully
- View error messages that inform you of problems encountered during testing

When to Use the Embedded System Diagnostics

If a major component or device in the system does not operate properly, component failure may be indicated. As long as the processor and the system's input/output devices are functioning, you can use the embedded system diagnostics to help identify the problem.

Running the Embedded System Diagnostics

The embedded system diagnostics program is run from the Dell Unified Server Configurator (USC) screen.

 **CAUTION:** Use the embedded system diagnostics to test only your system. Using this program with other systems may cause invalid results or error messages.

- 1 As the system boots, press < F10 > .
- 2 Click **Diagnostics** in the left pane and click **Launch Diagnostics** in the right pane.

The **Diagnostics** menu allows you to run all or specific diagnostics tests or to exit.

System Diagnostics Testing Options

Click the testing option in the **Main Menu** window.

Testing Option	Function
Express Test	Performs a quick check of the system. This option runs device tests that do not require user interaction.
Extended Test	Performs a more thorough check of the system. This test can take an hour or longer.
Custom Test	Tests a particular device.
Information	Displays test results.

Using the Custom Test Options

When you select **Custom Test** in the **Main Menu** window, the **Customize** window allows you to select the device(s) to be tested, select specific options for testing, and view the test results.

Selecting Devices for Testing

The left side of the **Customize** window lists devices that can be tested. Click the (+) next to a device or module to view its components. Click (+) on any component to view the tests that are available. Clicking a device, rather than its components, selects all of the components of the device for testing.



NOTE: After you select all the devices and components that you want to test, highlight **All Devices** and then click **Run Tests**.

Selecting Diagnostics Options

From the **Diagnostics Options** area, select the test(s) you want to run on a device.

- **Non-Interactive Tests Only**—Runs only tests that require no user intervention.
- **Quick Tests Only**—Runs only the quick tests on the device.
- **Show Ending Timestamp**—Time stamps the test log.
- **Test Iterations**—Selects the number of times the test is run.
- **Log output file pathname**—Enables you to specify the diskette drive or USB memory key where the test log file is saved. You cannot save the file to a hard drive.

Viewing Information and Results

The following tabs in the **Customize** window provide information about the test and the test results:

- **Results**—Displays the test that ran and the result.
- **Errors**—Displays any errors that occurred during the test.
- **Help**—Displays information about the currently selected device, component, or test.

- **Configuration**—Displays basic configuration information about the currently selected device.
- **Parameters**—Displays parameters that you can set for the test.





Jumpers and Connectors

This section provides specific information about the system jumpers. It also provides some basic information on jumpers and switches and describes the connectors on the system board.

System Board Jumpers

Figure 8-1 shows the location of the configuration jumpers on the system board. Table 8-1 lists the jumper settings.

Table 8-1. System Board Jumper Settings

Jumper	Setting	Description
PWRD_EN	 (default)	The password feature is enabled (pins 2-4)
		The password feature is disabled (pins 4-6)
NVRAM_CLR	 (default)	The configuration settings are retained at system boot (pins 3-5)
		The configuration settings are cleared at the next system boot (pins 1-3)

System Board Connectors

Figure 8-1. System Board Connectors

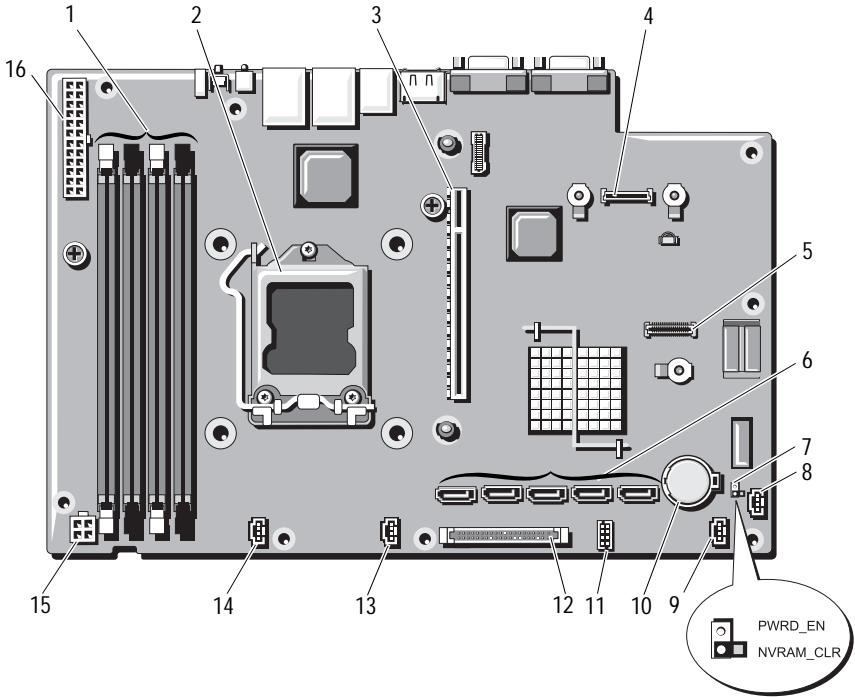



Table 8-2. System Board Jumpers and Connectors

Item	Connector	Description
1	3	Memory module slot 3
	1	Memory module slot 1 (white release lever)
	4	Memory module slot 4
	2	Memory module slot 2 (white release lever)
2	CPU	Processor
3	IO_RISER1	Expansion-card riser connector
4	iDRAC6 Enterprise	iDRAC6 Enterprise card connector
5	iDRAC6 Express	iDRAC6 Express card connector
6	SATA_E	SATA connector E
	SATA_D	SATA connector D
	SATA_C	SATA connector C
	SATA_B	SATA connector B
	SATA_A	SATA connector A
7	PWRD_EN	Password enable jumper
	NVRAM_CLR	NVRAM clear jumper
8	HD_ACT_CARD	Expansion-card cable connector
9	FAN3	System fan 3 connector
10	Battery	Battery socket
11	USB_CONN	Internal USB connector
12	CTRL_PNL	Control panel connector
13	FAN2	System fan 2 connector
14	FAN1	System fan 1 connector
15	12V	4-pin power connector
16	PWR_CONN	24-pin power connector

Disabling a Forgotten Password

The system's software security features include a system password and a setup password, which are discussed in detail in "Using the System Setup Program and Boot Manager" on page 25. The password jumper enables these password features or disables them and clears any password(s) currently in use.

 **CAUTION:** See "Protecting Against Electrostatic Discharge" in the safety instructions that came with the system.

- 1 Turn off the system, including any attached peripherals, and disconnect the system from the electrical outlet.
- 2 Open the system. See "Opening the System" on page 50.
- 3 Remove the jumper plug from the password jumper.
See Figure 8-1 to locate the password jumper (labeled "PWRD_EN") on the system board.
- 4 Close the system.
- 5 Reconnect your system and peripherals to their electrical outlets, and turn on the system.

The existing passwords are not disabled (erased) until the system boots with the password jumper plug removed. However, before you assign a new system and/or setup password, you must install the jumper plug.

 **NOTE:** If you assign a new system and/or setup password with the jumper plug still removed, the system disables the new password(s) the next time it boots.

- 6 Turn off the system, including any attached peripherals, and disconnect the system from the electrical outlet.
- 7 Open the system. See "Opening the System" on page 50.
- 8 Install the jumper plug on the password jumper.
- 9 Close the system. See "Closing the System" on page 51.
- 10 Reconnect your system and peripherals to their electrical outlets, and turn on the system.
- 11 Assign a new system and/or setup password.
To assign a new password using the System Setup program, see "Assigning a Setup Password" on page 42.

Getting Help

Contacting Dell

For customers in the United States, call 800-WWW-DELL (800-999-3355).



NOTE: If you do not have an active Internet connection, you can find contact information on your purchase invoice, packing slip, bill, or Dell product catalog.

Dell provides several online and telephone-based support and service options. Availability varies by country and product, and some services may not be available in your area. To contact Dell for sales, technical support, or customer service issues:

- 1 Visit **support.dell.com**.
- 2 Click your country/region at the bottom of the page. For a full listing of country/region click **All**.
- 3 Click **All Support Options** from the **Support** menu.
- 4 Select the appropriate service or support link based on your need.
- 5 Choose the method of contacting Dell that is convenient for you.

Index

B

back-panel features and indicators, 14

battery (system)
replacing, 89

bezel, 49

BMC
configuring, 44

C

cabling
optical drive, 52

CD drive
troubleshooting, 107

CD/DVD drive
See optical drive.

chassis intrusion switch, 48

contacting Dell, 119

control panel assembly
installing, 93
removing, 91

cooling fan
replacing, 75

cooling fans, 74
troubleshooting, 103

cooling shroud

installing, 69
removing, 67

cover
closing, 51
opening, 50

D

damaged systems
troubleshooting, 101

Dell
contacting, 119

diagnostics
advanced testing options, 113
when to use, 112

DIMMs
See memory modules (DIMMs).

E

error messages, 26

expansion card
installing, 62
removing, 61
troubleshooting, 109

expansion slot, 61

F

front-panel features and indicators, 12

G

guidelines

- connecting external devices, 15
- expansion card installation, 61
- memory installation, 69

H

hard drive
installing, 58
troubleshooting, 108

hard drives (cabled)
removing, 56

heat sink, 84

I

iDRAC Configuration Utility, 45

iDRAC6 Enterprise Card, 79

iDRAC6 Express Card, 76

indicators

- back-panel, 14
- NIC, 16

installing

- control panel assembly, 93
- cooling shroud, 69
- expansion card, 62

expansion-card riser, 65
hard drive, 58
memory modules, 71
optical drive, 52
processor, 86
system board, 93

J

jumpers (system board), 115

K

keyboards
troubleshooting, 98

M

memory
troubleshooting, 104

memory modules (DIMMs)
configuring, 69
installing, 71
removing, 73

messages
error messages, 26
warning, 22

N

NIC
indicators, 16

NICs

troubleshooting, 99

O

optical drive
installing, 52

options
system setup, 27

P

password
disabling, 118
setup, 42
system, 40

phone numbers, 119

POST
accessing system features, 11

power supply
removing, 87
replacing, 89
troubleshooting, 103

processor
removing, 82, 86
See processor.
troubleshooting, 110
upgrades, 82

R

removing
bezel, 49
control panel assembly, 91

cooling shroud, 67
cover, 50
expansion card, 61
hard drive (cabled), 56
memory modules, 73
power supply, 87
processor, 82, 86
system board, 93

replacing
cooling fan, 75
power supply, 89
system battery, 89

running the system
diagnostics, 111

S

safety, 97
SAS hard drive. *See* hard drive.
SATA hard drive. *See* hard drive.
securing your system, 35, 41
setup password, 42
slots
See expansion slots.
startup
accessing system features, 11
support
contacting Dell, 119
system
closing, 51
opening, 50
system board

- installing, 95
- jumpers, 115
- removing, 93
- system cooling
 - troubleshooting, 103
- system features
 - accessing, 11
- system password, 40
- system setup
 - options, 27
- system setup program
 - boot settings, 31
 - entering, 26
 - integrated devices options, 31
 - keystroke, 26
 - memory settings, 29
 - PCI IRQ assignments, 32
 - power management options, 34
 - processor settings, 29
 - SATA settings, 30
 - serial communications
 - options, 33
 - system security options, 35
- system setup screens
 - main, 27

T

- telephone numbers, 119
- TPM security, 35
- troubleshooting, 106
 - CD drive, 107
 - cooling fan, 103

- damaged system, 101
- expansion card, 109
- external connections, 97
- hard drive, 108
- internal USB key, 106
- keyboard, 98
- memory, 104
- NIC, 99
- power supply, 103
- processor, 110
- system cooling, 103
- video, 98
- wet system, 100

U

- UEFI Boot Manager
 - entering, 37
 - main screen, 38
 - System Utilities screen, 39
- UEFI Boot Manager Screen, 38
- upgrades
 - processor, 82
- USB device
 - back-panel connectors, 14
- USB key
 - troubleshooting, 106

V

- VFlash media, 82
- video
 - troubleshooting, 98

W

warning messages, 22

wet system

troubleshooting, 100

